

2019 SILVER SPOTLIGHT

**SOUTHERN
LOCK** EAS
Electronic Access
Specialists

- and -

**SILVER
SALES**



NOW A PREMIERE DISTRIBUTOR OF



SARGENT AND GREENLEAF®

ALSO FEATURING

dormakaba



**KABA
MAS**

SILVER SALES A DIVISION OF SOUTHERN LOCK



March 1, 2019 – Southern Lock and Supply Company announced that it has acquired Silver Sales Inc., a security hardware distribution company specializing in safe locks and government hardware. The purchase will better serve the security needs of customers in commercial, industrial, and governmental positions throughout the industry.

Founded in 1982, Silver Sales Inc. has faithfully served customers in the safe lock and government security for over 30 years. The purchase of Silver Sales strengthens Southern Lock’s promise to provide customers with a wide range of trusted security products and extraordinary service. In addition, Southern Lock will become a premiere distributor of Sargent & Greenleaf and Kaba Mas security products.

Bill and Judee Silver will remain involved in a consulting capacity, providing technical support for Southern Lock.

“We have always admired the trust and expertise that Silver Sales has exemplified in their market. As a fellow small business that understands the importance of personal connection, we’re thrilled to honor Silver Sales’ commitment to provide both tremendous customer service and comprehensive technical expertise,” said David Swartz, Chief Operating Officer of Southern Lock and Supply. “Our acquisition of Silver Sales is an exciting opportunity for us to expand our offerings to our existing customer base and grow our presence in the safe lock and government supply markets.”

ABOUT SOUTHERN LOCK



Southern Lock & Supply Company has been a distributor of security products and supplies since 1946. With merchandise from more than 200 manufacturers, Southern Lock maintains a large inventory of popular lines including Allegion, ASSA ABLOY, BEST Access Solutions, dormakaba, Sargent & Greenleaf, Master Lock, NSP, and more. With multiple locations and a knowledgeable inside staff, the company is able to achieve its goal of providing customers with quality products and the best service possible.

Southern Lock is a family business and we want our customers to feel like part of our family. We want to get to know you and your business, not just take your order or treat you like a number. Southern Lock has been serving the industry for over 70 years and is proud to represent an accumulated industry experience totaling 800 years. Our team is here to help your business grow.

LOCATIONS

Main Florida Warehouse

Toll-Free: 800-282-2837
Fax: 800-447-2299
PO Box 1980,
Pinellas Park, FL 33780

South Florida

Toll Free: 888-780-6071
Fax: 954-943-4211
1445 SW 6th Ct.,
Pompano Beach, FL 33069

Charlotte

Toll-Free: 888-571-9145,
Fax: 704-527-0058
8200-C Arrowridge Blvd,
Charlotte, NC 28273

SAFE LOCKS

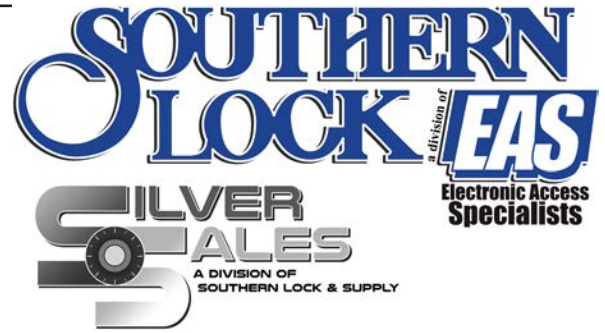

dormakaba

| | |
|--|-----|
| X-10 High Security Combination Safe Lock..... | 4 |
| DKX High Security Exit Devices & Door Locks..... | 4 |
| CDX-10 High Security Door Lock..... | 5 |
| Auditcon 2 Series Safe Locks..... | 6-7 |
| Cencon ATM Cash Vault Security System..... | 8 |
| Parts & Accessories..... | 9 |

Sargent & Greenleaf

Electronic Safe Locks.....10-16

| | |
|---|-------|
| AxisBlu Bluetooth Safe Locks..... | 10 |
| 6120 Motorized Safe Locks..... | 11 |
| 2006/2007 Titan Safe Locks..... | 12-13 |
| 1006/1007 Spartan Safe Locks..... | 14-15 |
| 6126/6127 Motorized Audit Safe Locks..... | 16 |

Government Hardware.....16-20

| | |
|--|----|
| 2740 High-Security Electromechanical Safe Locks..... | 16 |
| 2890B Pedestrian Door Locks..... | 17 |
| 8497 Brute Electronic Door Deadlatches..... | 18 |
| 2937 Model Group 1 Mechanical Safe Locks..... | 19 |
| Extension 50 Mechanical Automatic Door Deadbolt..... | 20 |
| 1881 Sliding Mechanical Deadbolts..... | 20 |

Mechanical Safe Locks.....21-25

| | |
|---|----|
| 6730/6731 Series Group 2 Mechanical Safe Locks..... | 21 |
| 6741 Series Group 2 Mechanical Safe Locks..... | 22 |
| 6630 Group 2M Mechanical Safe Locks..... | 22 |
| 8410 Series Group 1 Mechanical Safe Locks..... | 23 |
| 8550/8560 Group 1 & Group 1R Mechanical Safe Locks..... | 23 |
| 6804/6824 Key-Op Key Operated Safe Locks..... | 24 |
| 6870 Series Key Operated Safe Locks..... | 24 |
| 6500 Series Mechanical Vault Locks..... | 25 |

Tools, Dials, Rings, and Parts.....25-28

| | |
|---------------------------------|-------|
| Pro-Lok Safe "Butter" Bits..... | 25 |
| Dials..... | 26 |
| Parts..... | 26-31 |
| Rings..... | 27 |
| Safe Deposit Hardware..... | 31-32 |
| Safety Deposit Keyblanks..... | 32 |

PADLOCKS

Sargent & Greenleaf

Padlocks.....33-35

| | |
|---------------------------------------|-------|
| 951C High Security & Hasps..... | 33 |
| 0881/0883 Environmental Padlocks..... | 34-35 |
| 8077AD Combination Padlocks..... | 35 |

dormakaba

X-10 High Security Combination Safe Lock Impervious to External Attack

The X-10 was designed and developed as a direct result of the latest revision to federal specification FF-L-2740 (now Revision "B"). This is the US Government's highest security standard for container locks and doors. The X-10 is approved for use on all GSA Approved Security Containers and Vault Doors. The X-10 is also approved for use on Federal Specification FF-L-2890B locks installed on pedestrian doors to Secure Rooms and Sensitive Compartmented Information Facilities (SCIFs).



- Self-powered using green "PowerStar" Technology - Rotate the dial to power-up the lock
- Intuitive, visual controls guide the operator through programming and audit features
- Same three modes of operation as the X-09:
 - Single: 1 million combinations
 - Dual: 500 billion combinations
 - Supervisor/Subordinate: 2 million combinations
- Direct Dial: No need to clear before entering combination. Once you stop turning the dial, the power will shut down after 40 seconds.
- Automatic Lock Reset
- High-Security combination scramble
- Resists all forms of external manipulation and environmental attack
- Backlit LCD display approved by GSA that eliminates the need for external light sources
- Lock case incorporates a through case mounting feature to improve ease of installation
- Audit: Records all openings, record is non-resettable

X-10 COMBINATION SAFE LOCKS

| ORDER # | ITEM # | LIST |
|----------|--|------------|
| 547-1107 | X-10X-RD-XXT-Z-M-E-Z-1A Security Combination Lock (for up to 4.5" thick doors) | \$1,933.05 |
| 547-1105 | X-10X-RD-XXT-Z-N-E-Z-1A w/ Flush Bolt, Tapped Holes. Longer spindle for up to 10" thick doors | \$2,269.05 |

ALSO AVAILABLE

DKX-10 High Security Pedestrian Exit Device FF-L-2890C Type IV

Developed to meet Government changes to Federal Specification FF-L-2890C. Used on GSA approved security containers and CDX series pedestrian door locks to secure rooms and Secure Compartmented Information Facilities (SCIFs). Preferred by U.S. Government agencies and Government contractors.

DKXL-10 High Security Pedestrian Door Lock FF-L-2890C Type II

The GSA has approved the Type II DKXL-10, which is comprised of a CDX-10, attached – through linkage – to a BEST Grade 1, heavy duty cylindrical lock. Linkage ensures simultaneous retraction of both the secondary cylindrical lock latch bolt and the CDX-10 primary lock bolt. The combination of two proven products ensures compliance with codes for security, fire, and life safety and ADA requirements. For use on both inswing & outswing doors.



SPECIAL ORDER
Call for more info



CDX-10 High Security Pedestrian Door Lock

GSA Approved to meet Federal Specification FF-L-2890B, Type V

The Kaba Mas CDX-10 consists of a GSA approved, style 1 X-10 High Security combination lock mounted on a deadbolt base plate. The base plate is surface-mounted to the inside of the face of the door. The system provides a means of using a GSA approved combination lock to secure pedestrian doors on type VI secure spaces. Product features include:

- A means of latching the primary locking bolt in the retracted position to allow authorized personnel to access the area through an access control system during operational hours of the facility
- An inside knob that can be rotated to allow egress when the primary locking system is activated



CDX-10 COMBINATION SAFE LOCKS

| ORDER # | ITEM # | LIST |
|----------|--|------------|
| 547-1108 | CDX-10 Combination Door Unit with Non-Drill Resistant Hard Plate, #1 Strike, 521025/521030 | \$2,503.20 |
| 547-1109 | CDX-10 Combination Door Unit with Non-Drill Resistant Hard Plate, #2 Strike, 521025/521031 | \$2,503.20 |
| 547-1110 | CDX-10 Combination Door Unit with Non-Drill Resistant Hard Plate, #3 Strike, 521025/521032 | \$2,503.20 |
| 547-1111 | CDX-10 Combination Door Unit with Non-Drill Resistant Hard Plate, #9 Strike, 521025/521033 | \$2,503.20 |

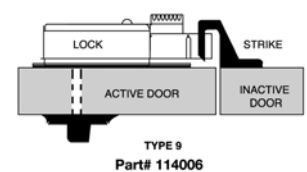
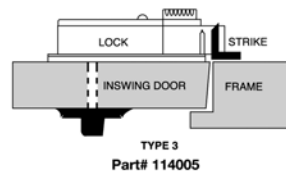
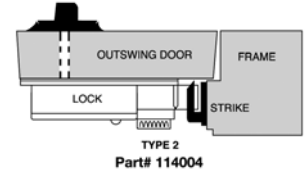
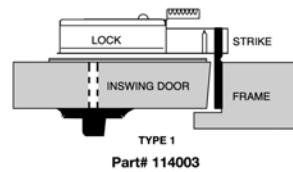

EXTERNAL MOUNTING PLATES

| ORDER # | ITEM # | LIST |
|----------|----------------------------|----------|
| 547-1013 | 111204 Non-Drill Resistant | \$110.00 |

CDX-10 STRIKE KITS

Can also be used with CDX-09

| ORDER # | ITEM # | LIST |
|----------|-------------------|---------|
| 547-0001 | MHG #1 Strike Kit | \$23.10 |
| 547-0002 | MHG #2 Strike Kit | \$50.40 |
| 547-0003 | MHG #3 Strike Kit | \$44.10 |
| 547-0009 | MHG #9 Strike Kit | \$74.55 |



Auditcon 2 Series® Safe Locks

Auditcon locks are the new standard in safe lock security and audit capability. The Auditcon lock series features PowerStar's award winning technology and cannot be compromised by outside manipulation. With unprecedented audit capability, the Auditcon family of electronic locks was developed to address the security requirements of a broad range of financial, retail, commercial and industrial markets. All models are available in either Round or Vertical housings.

Features and Benefits

- **PowerStar Technology:** Self-powered. No batteries, no wiring, no maintenance.
- **SmartKey Capability** allows convenient data download and transport for PC viewing and offers dual-level security that requires a four digit PIN and personal encoded key to gain access.
- **Audit Trail:** User's ID is recorded every time the lock is opened.
- **Wrong Try Lock-out:** Hackers are locked out after 5 wrong combinations.
- **Economical Replacement:** Utilizes the same footprint as most conventional mechanical combination lock.
- **Time Delay** for 1 to 99 minutes.
- **Time Delay Display** displays the time, informing the user when access will be granted.
- **Battery Assist for Time Delay:** 9-volt battery will continually flash the LEDs throughout the duration of a Time delay or Open Window Period
- **Dual Mode** requires the combination and/or Smart keys of two users to gain access.
- **Silent Duress Alarm** safely lets employees comply with intruder's demands while alerting authorities
- **Audit Only Software** allows you to save or print audit trail information from your PC.
- **Choice of Bolt Designs:** The "Swing Bolt" automatically locks when the safe handle is closed. The standard 'Dead Bolt' functions like a traditional mechanical combination dial lock.
- **Technical Support:** Kaba Mas Technical Support Staff is available 24 hours a day, seven days a week. Call 888-950-4715 or 859-253-4744.

Model 52/T52



Model 52 is supplied with all basic functions for residential and commercial applications with the convenience of electronic locking. Alternatively, the **T52** is available with time delay functions

- 2 users
- 6 digit access
- Replaces mechanical Group I & II locks
- Round or vertical housing
- Dead bolt or swing bolt available
- EN 1300 B, VdS class 2, SBSC, UL type 1

Model 252



Model 252 is ideal for security applications where shared access and audit capability are crucial.

- 20 users/100 record audit
- 8 digit access combination
- Replaces mechanical Group I & II locks
- Round or vertical housing
- Dead bolt or swing bolt available
- EN 1300 B, VdS class 2, SBSC, UL type 1

Model 552



Model 552 provides advanced features including: Time Window Access, Time Delay, Time Lock functions plus a time and date stamped audit trail. The locking periods can easily be set with the software and programmed to the lock via Smart Key.

- 99 users/400 record audit
- 8 digit access combination
- Replaces mechanical Group I & II locks
- Round or vertical housing
- Dead bolt or swing bolt available
- EN 1300 B, VdS class 2, SBSC, UL type 1



SAFE LOCKS



Auditcon Lock Series® Specifications and Ordering Information

| ORDER # | ITEM # | BOLT | HOUSING | COMBINATION | PC SOFTWARE | ALARM INTERFACE | LIST |
|----------|-------------------|-------|----------|---------------------------------------|-------------|-----------------|----------|
| 547-0050 | 052S RN 10N 5 | Dead | Round | 6 Digits | - | | \$284.00 |
| 547-1050 | 052S VN10N58EA1A | Dead | Vertical | 6 Digits | - | | \$295.25 |
| 547-1200 | 252 VN 10N5 | Dead | Vertical | 8 Digits | Optional * | Optional | \$336.00 |
| 547-0090 | 25WS VN 75N8 | Swing | Vertical | 8 Digits | Optional * | Optional | \$349.50 |
| 547-0140 | 55WA VN 75N9MEA1A | Swing | Vertical | 8 Digits | Optional ** | Optional | \$735.25 |
| 547-0150 | 2100 D | Dead | Vertical | 8 Digits or 4 Digits & SmartKey | Yes *** | Yes | \$295.25 |

* Audit only
 ** Audit/Programmable Time Windows
 *** Full Programming and Auditing

OPTIONS:

| ORDER # | ITEM # | LIST |
|----------|---------------------------------------|----------|
| 547-0160 | 307025 Remote Time Delay Display | \$208.50 |
| 547-0170 | 301040 Duress Alarm Interface Kit | \$99.00 |
| 547-3000 | Mas-Hamilton Personal Identifier Keys | \$37.80 |

APPLICATION TIP:

Businesses that have multiple employee access, multiple locations, absentee ownership, or high employee turn-over are ideal for Auditcon locks. Auditcon locks can secure safes, containers, vaults, and restricted areas for restaurants, ticket box offices, convenience stores, grocery stores, department stores, drugstores, jewelry stores, banks, hospitals, ccasinos, police stations, etc.

| AUDIT TRAIL INFO | #52 | #200 | #400 | #500 | #2100 |
|---|-----|----------|----------|----------|-------|
| NUMBER OF EVENTS (in sequential order) | - | 100 | 200 | 400 | 888 |
| TIME/DATE STAMP | - | - | Yes | Yes | Yes |
| AUDIT TRAIL REPORT | - | Optional | Optional | Optional | Yes |



Cencon ATM Cash Vault Security System

The Cencon ATM Cash Vault Security System from Kaba Mas is designed to combat insider theft from ATMs through the combined use of lock hardware, systems software and Smart Keys™. Cencon offers total access control and accountability with its One Time Combination™ feature. The One Time Combination is dispatched from a central location and cannot be reused at a later date, thus eliminating temptation. Unique software allows you to control and monitor tens, hundreds, even thousands of locks located anywhere in the world - from one central location. Cencon is a revolutionary and cost-effective solution to today's most serious security challenges.

Dial & Keypad
3.79" H x 3.83"
W x 1.38" D

Lock Body
2.4" H x 3.34"
W x 1.19" D



Features and Benefits

- **PowerStar Technology:** Use of an internal generator creates all the necessary power. No batteries or external wiring required.
- **Access Control:** A user needs both a One Time Combination and a SmartKey to access the lock.
- **One Time Combination:** Dispatched each time access is required to a container controlled by a Cencon lock.
- **SmartKey:** An encrypted electronic key, used as a personal identifier, programming device or to transfer data between system components.
- **Close Seal:** Acts as an electronic signature, stamping the date and time showing the lock was locked and secured.
- **Duress:** When combined with a connection to an alarm system, entering a special "Duress" Combination will automatically send a silent alarm.
- **Audit Trail:** Records all lock activity up to 956 events, and permits easy downloading of the information via a SmartKey for generating detailed audit reports.
- **Easy Retrofit:** Same footprint as conventional mechanical combination locks.
- **User Friendly Software:** Allows you to control hundreds of containers with no special wiring. The Windows 95/98 point-and-click interface makes it simple to install and use.
- **Three Modes of Operation:** Cencon locks can operate in any of three modes - one for the First Line Maintenance personnel (FLM Mode), one for cash replenisher or armored service (Route Mode), and one for bank employees (Bank Mode). Each mode addresses the individual access needs for each category of user. Cencon System 2000 locks can be operated in any of these three modes - individually or in combination.

CENCON LOCK NON-SHUNTED, KEYPAD UP

| ORDER # | ITEM # | LIST |
|----------|-----------------|----------|
| 547-3093 | CSD2KU0067HEB2A | \$935.00 |

CENCON LOCK FOR 55MM DOOR W/ ALARM SHUNT

| ORDER # | ITEM # | LIST |
|----------|---------------|------------|
| 547-4010 | CSS2KU67HEB2A | \$1,035.00 |

SMARTKEYS

| ORDER # | ITEM # | DESCRIPTION | CATEGORY | COLOR | LIST |
|----------|----------------|----------------------------------|---------------|------------|---------|
| 547-4020 | 202020 ASM, F | Fire Line Maintenance Personnel | Lock User | Blue | \$46.00 |
| 547-4022 | 202022 ASM, R | Route Mode Personnel | Lock User | Yellow | \$46.00 |
| 547-3076 | 202270 ASM, B | Bank Mode Personnel | Lock User | Green/Teal | \$46.00 |
| 547-4030 | 212030 ASM, A | Additional Logon to KMU | Software User | Orange | \$46.00 |
| 547-4028 | 202227 ASM, L | Logon Key (D, S, SS) | Software User | Black | \$46.00 |
| 547-4021 | 202021 ASM, SA | Supervisor Audit | Data Transfer | Red | \$46.00 |
| 547-3035 | 202226 ASM, CS | Clock Set (Gen2 Lock & Cencon 4) | Data Transfer | White | \$75.00 |
| 547-3034 | 202224 ASM, RS | Re-Sync (Gen2 Lock & Cencon 4) | Data Transfer | Dark Grey | \$46.00 |



AUDITCON/CENCON PARTS

| ORDER # | ITEM # |
|----------|--|
| 547-3030 | KABA 311101 Clip (pk/50) |
| 547-3031 | KABA 201164 Spindle 9.84" DT (pk/10) |
| 547-3032 | KABA 201165 Tube 2.17" DT (pk/10) |
| 547-3033 | KABA 201175 Back Cover Gen 2 W/Electronic Card, Non-Shunted Screws |
| 547-3036 | KABA 204248 Metric Screw Pack for Cencon |
| 547-3066 | KABA CL20SMK5DMWAE1A |
| 547-3075 | KABA 201139 KU Standard Keypad |
| 547-3094 | KABA 305301 Universal Relocker Plate |

X-10/CDX-10 PARTS

| ORDER # | ITEM # |
|----------|--|
| 547-3067 | KABA 504085 Dial Retaining Rings (pk/50) |
| 547-3068 | KABA 107061 X-10 Change Key |
| 547-3069 | KABA 504068 X-10 Dial |
| 547-3070 | KABA 504075 X-10 Dial Ring |
| 547-3072 | KABA 521000 Conversion Kit for 10" DT |
| 547-3085 | KABA 104017 X-10 Tube Kit |
| 547-3095 | KABA 524004-X10 Spindle |
| 547-3096 | KABA 504067-X10 Hub |

524002 X-10 Lock Mounting Kit

Includes:

- Hex key, 5/64" Long (1)
- Tube Deburr Stone (1)
- Saw Blade (1)
- Hub Gauge (1)
- Vise Clamp (1)
- Cable Retainer (3)
- Saw Handle (1)
- Screw Case 1/4-20 x .38 (4)
- Screw Case 1/4-20 x .31 (4)
- Insulator, Tape M85-89 (1)
- Zebra Connector Housing (1)
- Zebra Connector, SPL (1)
- Lubricant, Tube Lubriplate Grease (1)
- Spindle Screw PH 6.32 x .395 (1)
- Screw-PH 8/32 x 5/16 (4)



| ORDER # | ITEM # |
|----------|------------------------------------|
| 547-3097 | KABA 524002 X-10 Lock Mounting Kit |

MISC. PARTS

| ORDER # | ITEM # |
|----------|---------------------------------|
| 547-3037 | KABA 67002026D |
| 547-3039 | KABA 670G0100301458B |
| 547-3041 | KABA 67103 Key Locking Plugs |
| 547-3042 | KABA 67109 Inserts for D30 NKL |
| 547-3043 | KABA 67110 Dial Cap-Insert |
| 547-3044 | KABA 67125 Insert for D55 |
| 547-3045 | KABA 67127 Dial Cap-Insert |
| 547-3047 | KABA 67121 Bolt |
| 547-3048 | KABA 6840006041 4 Wheel 2M Lock |
| 547-3049 | KABA N69878 |
| 547-3050 | KABA N69879 Mosler Kit 2 |
| 547-3051 | KABA A4021000401LH SD Lock LH |
| 547-3052 | KABA A4021000401RH SD Lock RH |
| 547-3053 | KABA A4031000401LH SD Lock LH |
| 547-3054 | KABA A4031000401RH SD Lock RH |
| 547-3061 | KABA A40-005 LH 1/2" |
| 547-3063 | KABA C402RH Lock |
| 547-3064 | KABA C403LH Lock |
| 547-3065 | KABA C403RH Lock |
| 547-3073 | KABA 9810004 Lube |
| 547-3079 | KABA 260775-26D-91 1/2" Chrome |
| 547-3080 | KABA 401100-04-01LH |
| 547-3081 | KABA 54-003 3/8" Cover (pk/10) |
| 547-3082 | KABA C402LH Lock |



SARGENT AND GREENLEAF®

ELECTRONIC SAFE LOCKS

AxisBlu™ Bluetooth Enabled Safe Lock

AxisBlu combines the latest Bluetooth technology upgrades with S&G's Titan lock body to create a radical new option for safe security—accessing your safe securely via mobile app. AxisBlu is the first secure safe lock with a no keypad option. Users may choose from a sleek, modern medallion or our tried-and-true traditional gun safe lock keypad.



Keypad



Medallion

AxisBlu Features

- **BLUETOOTH INNOVATION.** The latest Bluetooth upgrades bring the technology up to S&G's stringent security standards. New functionality and multiple levels of authentication in mobile devices make AxisBlu's Bluetooth connectivity a reliable, fully secure method of access.
- **PROVEN SECURITY.** Backed by the proven security of S&G's trusted Titan motorized locking device, AxisBlu adds firmware enhancements for even greater protection.
- **STARTLING CONVENIENCE.** AxisBlu pairs with up to five mobile devices along with ten users—allowing lightning fast Bluetooth access via our AxisBlu app.
- **EASY INSTALLATION.** Although AxisBlu leverages multiple components for added security, we designed the lock for easy installation—matching standard safe lock footprints and machining.

AXISBLU KEYPAD KITS

Complete kit including Keypad, Lock Body, and Bluetooth Module

| ORDER # | ITEM # | LIST |
|----------|---|-----------------|
| 735-2147 | SRG AX26-202 AxisBLU Bluetooth Safe Lock with Matte Black KP | \$310.08 |
| 735-2148 | SRG AX26-302 AxisBLU Bluetooth Safe Lock with Black Platinum KP | \$335.92 |



AXISBLU MEDALLION KIT

Complete kit including Medallion, Lock Body, Battery Box, and Bluetooth Module

| ORDER # | ITEM # | LIST |
|----------|---|-----------------|
| 735-2146 | SRG AX26-102 AxisBLU Bluetooth Safe Lock with Medallion Kit | \$310.08 |



ELECTRONIC SAFE LOCKS



SARGENT AND GREENLEAF®

6120 Motorized Electronic Safe Locks Shorter time delay and one-step operation

A motorized electronic safe lock, the Model 6120 gives you the added convenience and control you want for greater security. Its motor-driven lock bolt offers a high level of security by eliminating the threat of vibration and bouncing attacks. Universally handed with a shorter time delay and one-step operation, it is perfect for home gun safes or safes in small commercial facilities.



Model 6120 Features

- Motor-driven lock bolt eliminates threat of vibration and bouncing attacks.
- Auto relocks after 6 seconds. Eliminates the dangerous practice of “day locking” or leaving the safe open.
- Penalty time feature prevents opening until a valid code is found and locks after three wrong code entry attempts.
- Management reset code, one master code, and eight user codes.
- Management reset code (MRC) restores the lock to its original factory code if the master code is lost.
- Non-deadlocking spring bolt model is designed for lightweight and inner compartment doors that require the lock to latch and secure the door.

LOCK BODIES WITH KEYPADS

| ORDER # | ITEM # | LIST |
|----------|--|----------|
| 735-2142 | SRG 6120-305 Lock and Keypad with Square Bolt and Two Battery Satin Chrome Keypad, Type 1, Factory-set MRC | \$290.49 |
| 735-2348 | SRG 6120-508 Lock and Keypad with Spring Bolt and Two Battery Satin Chrome Keypad, Factory-set MRC | \$409.30 |

LOCK BODIES ONLY

| ORDER # | ITEM # | LIST |
|----------|---|----------|
| 735-2334 | SRG 6120-308 Square Bolt Lockbody with Factory-set MRC | \$259.42 |
| 735-0010 | SRG 6120-309 Square Bolt Lockbody Field-settable MRC (Must be set before resetting master code) | \$259.42 |
| 735-2143 | SRG 6120-504 Spring/Latch Bolt Lockbody with Factory-set MRC | \$286.66 |

KEYPADS ONLY

| | ORDER # | ITEM # | LIST |
|----------------|----------|---|----------|
| SINGLE BATTERY | 735-2137 | SRG 6120-210 Single Battery Std. Keypad, OBC, Buffed Chrome | \$63.32 |
| | 735-2138 | SRG 6120-211 Single Battery Std. Keypad, OBB, Buffed Brass | \$64.97 |
| | 735-2140 | SRG 6120-235 Single Battery Lighted Keypad, PivotBolt, Buffed Brass | \$75.46 |
| | 735-2141 | SRG 6120-240 Single Battery Lighted Keypad, PivotBolt, Black Platinum | \$74.20 |
| TWO BATTERY | 735-0015 | SRG 6120-010 Two Battery Keypad, Buffed Brass finish | \$91.64 |
| | 735-0025 | SRG 6120-014 Two Battery Keypad, Matte Black finish | \$80.34 |
| | 735-0020 | SRG 6120-016 Two Battery Keypad, Satin Chrome finish | \$80.34 |
| | 735-2135 | SRG 6120-045 Two Battery Keypad, 24k Gold finish | \$151.22 |

6120 SERIES PARTS & ACCESSORIES

| ORDER # | ITEM # | LIST |
|----------|--|----------|
| 735-2136 | SRG 6120-064 Two Lock Wiring Kit | \$100.91 |
| 735-2145 | SRG 6130-100 Spyshield for Electronic Keypad | \$54.46 |



SARGENT AND GREENLEAF®

ELECTRONIC SAFE LOCKS

2006/2007 Titan™ Electronic Safe Locks Motor driven locking for an extra measure of security

The Model 2006/2007 Titan safe lock, a robust, 10-user lock, comes with a completely redesigned locking mechanism that is based on the proven security of a rugged, motorized blocking device. These electronic safe locks are often used in the banking and commercial industries to protect key assets. Uses standard S&G Magic Module footprint for easy retrofit, and it's universally handed and reversible for RH, LH, VU, and VD mounting.

Three modes of operation:

- Multi-User—The Master Code, Supervisor Code, and any User Code can open the lock with a single code.
- Manager/Employee—Code holders can access the safe only when it's been enabled by a Master Code or Supervisor Code holder.
- Dual Control—Multi-User mode is the factory default, but Dual Control is keypad selectable as an alternate, permanent mode of operation. Two different lock codes must be entered within one minute of each other to open the safe. This provides a higher level of security.

2006 Titan™ PivotBolt™



The Titan PivotBolt automatically locks to re-secure the safe whenever the container's boltwork moves to the fully closed position. Lock bolt retraction and extension is controlled by the movement of the safe's boltwork. Withstands 225 lbs of bolt end pressure for a high level of security in boltwork blocking applications.

- Connected to the keypad only by cable, which means the lock does not need to be placed directly behind the keypad. It can be located anywhere on the inside of the safe door.
- Penalty time feature to prevent opening by entering sequential or random codes until a valid code is found.
- Can be used with the S&G 2-battery keypad, standard 1-battery keypad (lighted and non-lighted), or the non-rotating low profile keypad

LOCK BODY WITH KEYPAD

| ORDER # | ITEM # | LIST |
|----------|--|----------|
| 735-2012 | SRG 2006-108 Titan PivotBolt & Standard Keypad, Chrome | \$223.72 |

KEYPADS ONLY

| ORDER # | ITEM # | LIST |
|----------|--|----------|
| 735-2137 | SRG 6120-210 Single Battery Std. Keypad, OBC, Buffed Chrome | \$63.32 |
| 735-2138 | SRG 6120-211 Single Battery Std. Keypad, OBB, Buffed Brass | \$64.97 |
| 735-2140 | SRG 6120-235 Single Battery Lighted Keypad, PivotBolt, Buffed Brass | \$75.46 |
| 735-2141 | SRG 6120-240 Single Battery Lighted Keypad, PivotBolt, Black Platinum | \$74.20 |
| 735-0015 | SRG 6120-010 Two Battery Keypad, Buffed Brass finish | \$91.64 |
| 735-0025 | SRG 6120-014 Two Battery Keypad, Matte Black finish | \$80.34 |
| 735-0020 | SRG 6120-016 Two Battery Keypad, Satin Chrome finish | \$80.34 |
| 735-2135 | SRG 6120-045 Two Battery Keypad, 24k Gold finish | \$151.22 |

* Keypads not compatible with D-Drive models

ELECTRONIC SAFE LOCKS



SARGENT AND GREENLEAF®



2007 Titan™ D-Drive™

The Titan D-Drive's lock bolt retraction and extension is controlled by turning of the keypad, offering dependable manual control of the locking bolt. Exclusive no-twist cable design prevents cable damage with keypad rotation. Withstands 225 lbs of bolt end pressure for a high level of security in boltwork blocking applications.

LOCK BODY WITH KEYPAD

| ORDER # | ITEM # | LIST |
|----------|--|----------|
| 735-2010 | S&G 2007-102 Titan D-Drive & Rotating Keypad, Chrome | \$246.50 |

Titan™ D-Drive™ Features:

- The Titan D-Drive™ lock features a new design, motor driven locking mechanism for an extra measure of security and longer battery life.
- Lock bolt retraction and extension is controlled by turning of the keypad, offering dependable manual control of the locking bolt. And the sure-grip, low profile keypad gives a good, solid feel for the action of the lock.
- The Titan D-Drive™ uses an exclusive, no-twist cable design that virtually eliminates the risk of cable damage due to keypad rotation. The cable is located in a recessed channel in the lock's extruded aluminum spindle, safely out of harm's way.
- The Titan D-Drive™ uses the standard S&G Magic Module footprint, allowing for easy retrofit without the need for boltwork or mounting screw location changes. Plus, it's universally handed for RH, LH, VU, and VD mounting.
- Management reset code, one master code, one supervisor code, eight user codes, and one time delay override code.
- The management reset code (MRC) lets you set a new master code of your own choosing if the old master code is lost or forgotten. **Using MRC wipes out all existing codes and settings and restores back to original factory settings.**
- The Titan D-Drive™ has a penalty time feature to prevent opening by entering sequential or random codes until a valid code is found.

SPECIAL ORDER

| D-DRIVE KEYPADS | |
|-----------------|---|
| ITEM # | |
| 6130-200 | Rotating Keypad only, Chrome Ring, Blue Button, Not Lighted |
| 6130-312 | Lighted Keypad only, Buffed Chrome |





SARGENT AND GREENLEAF®

ELECTRONIC SAFE LOCKS

1006/1007 Spartan™ Electronic Safe Locks Anti-shock technology and automatic locking

- External battery placement puts the battery inside the keypad, where it can be easily replaced, even with the safe locked. And efficient lock design means the battery must be changed significantly less often.
- The S&G® Spartan™ lock body is the same size and mounting footprint as other standard S&G locks, allowing for easy retrofit without the need for boltwork or mounting screw location changes. Plus, it's universally handed for RH, LH, VU, and VD mounting.

Spartan™ Features

- Simple, 2-user lock
- Manager can add, delete, or temporarily enable or disable the 2nd user code at any time
- Optional MRC (Management Reset Code)
- Two-year warranty
- Lock bolt relock verification signal (double beep/LED flash)
- Penalty lock-out after three wrong code entry attempts.
- Tested to 10,000 openings on a single Duracell® 9-volt alkaline battery.
- Low battery signal.
- Beeper volume toggle.
- Uses motorized bolt-blocking technology; not shock-susceptible solenoids.



1006 Spartan™ PivotBolt™

The PivotBolt™ is connected to its keypad only by cable and autolocks to re-secure the safe. No rigid spindle, so the lock does not have to be placed behind the keypad. It can be anywhere on the inside of the safe door.

LOCK BODIES WITH KEYPADS

| ORDER # | ITEM # | LIST |
|----------|---|----------|
| 735-2011 | 1006-102 Spartan PivotBolt & Low Profile Keypad, Chrome | \$159.72 |
| 735-2013 | 1006-108 Spartan PivotBolt & Standard Keypad, Chrome | \$155.08 |
| 735-2128 | 1006-118 Spartan PivotBolt & Standard Keypad, Black Plat. | \$157.72 |
| 735-2341 | 1006-100 Spartan PivotBolt Lockbody Only | \$96.73 |

KEYPADS ONLY

| | ORDER # | ITEM # | LIST |
|----------------|----------|---|----------|
| SINGLE BATTERY | 735-2137 | SRG 6120-210 Single Battery Std. Keypad, OBC, Buffed Chrome | \$63.32 |
| | 735-2138 | SRG 6120-211 Single Battery Std. Keypad, OBB, Buffed Brass | \$64.97 |
| | 735-2140 | SRG 6120-235 Single Battery Lighted Keypad, PivotBolt, Buffed Brass | \$75.46 |
| | 735-2141 | SRG 6120-240 Single Battery Lighted Keypad, PivotBolt, Black Platinum | \$74.20 |
| TWO BATTERY | 735-0015 | SRG 6120-010 Two Battery Keypad, Buffed Brass finish | \$91.64 |
| | 735-0025 | SRG 6120-014 Two Battery Keypad, Matte Black finish | \$80.34 |
| | 735-0020 | SRG 6120-016 Two Battery Keypad, Satin Chrome finish | \$80.34 |
| | 735-2135 | SRG 6120-045 Two Battery Keypad, 24k Gold finish | \$151.22 |

* Keypads not compatible with D-Drive models

ELECTRONIC SAFE LOCKS



SARGENT AND GREENLEAF®



1007 Spartan™ D-Drive™

The D-Drive™ lock cable is protected in a specially designed channel in the extruded aluminum spindle that connects the keypad to the lock body. The advanced design resists twisting and chafing in day-to-day operation.

LOCK BODY WITH KEYPAD

| ORDER # | ITEM # | LIST |
|----------|---|----------|
| 735-2014 | 1007-102 Spartan Direct Drive Keypad, Chrome, Spindle | \$173.14 |

PARTS & ACCESSORIES

| ORDER # | ITEM # | LIST |
|----------|---|---------|
| 735-2130 | 2004-500 Spartan D-Drive 8" Replacement Spindle | \$13.80 |

Spartan™ D-Drive™ Features:

- The Spartan™ D-Drive™ lock features a motor driven locking mechanism for an extra measure of security and longer battery life.
- Lock bolt retraction and extension is controlled by turning of the keypad, offering dependable manual control of the locking bolt. And the sure-grip, low profile keypad gives a good, solid feel for the action of the lock.
- The Spartan™ D-Drive™ uses an exclusive, no-twist cable design that virtually eliminates the risk of cable damage due to keypad rotation. The cable is located in a recessed channel in the lock's extruded aluminum spindle, safely out of harm's way.
- The Spartan™ D-Drive™ uses the standard S&G Magic Module footprint, allowing for easy retrofit without the need for boltwork or mounting screw location changes. Plus, it's universally handed for RH, LH, VU, and VD mounting.
- Two modes of operation, STAR and BASIC, to let you choose the operating procedures that are most intuitive to you.
- 2 codes available - 1 master code and 1 user code
- The management reset code (MRC) lets you set a new master code of your own choosing if the old master code is lost or forgotten. **Using MRC wipes out all existing codes and settings and restores back to original factory settings.**

SPECIAL ORDER

D-DRIVE KEYPADS

| ITEM # |
|--|
| 6130-200 Rotating Keypad only, Chrome Ring, Blue Button, Not Lighted |
| 6130-312 Lighted Keypad only, Buffed Chrome |





SARGENT AND GREENLEAF®

ELECTRONIC SAFE LOCKS

6126/6127 Motorized Audit Locks

- Will push and pull 2.24 lbs; maximum load 5.6 lbs
- Deadlocking, motor driven bolt withstands over 225 lbs. of end pressure.
- Field programmable (via keypad) for single control or dual control; changeable at any time.
- Up to thirty users: One programmer code, three manager codes, six supervisor codes, and twenty user codes.
- Programmable time delay up to 99 minutes.
- 400 event time and dated stamped audit trail (requires keypad extension and audit trail PC software).

- Penalty lockout feature shuts the lock down for ten minutes if 5+ incorrect codes are entered in a row.
- Duress alarm connection (requires optional duress module).



AUDIT TRAIL SOFTWARE

Comes with CD, USB Adapter with Cable, and Dallas Button for 6126/6127/6128/6129 Series Locks. SG Audit Software runs on Windows 7 and Windows Server 2008 platforms.

MOTORIZED AUDIT LOCK

With 30 Multi Users, Keypad, Keypad Extension, and Management Reset Code. Designed for direct boltwork attachment. Bolt Position Indicator not included.

| ORDER # | ITEM # | LIST |
|----------|-----------------------------------|----------|
| 735-2144 | SRG 6127-146 Motorized Audit Lock | \$350.00 |

| ORDER # | ITEM # | LIST |
|----------|---------------------------|----------|
| 735-2133 | SRG 6103-131 Software Kit | \$406.75 |

GOVERNMENT HARDWARE

2740 High-Security Electromechanical Safe Lock Built to the Requirements of Federal Specification FF-L-2740B

The Model 2740B lock is engineered and manufactured to meet the highest security standards of the U.S. Government for the protection of classified materials. Meeting Federal Specification FF-L-2740B, the Model 2740B electromechanical lock is used on GSA-approved security containers, including safes, security files and vault doors.



LOCKS & LOCK KITS

| ORDER # | ITEM # | LIST |
|----------|---|------------|
| 735-2740 | SRG 2740-100 High Sec. Safe Lock Kit Need Set-Up Module to program | \$1,917.46 |
| 735-2349 | SRG 2740-400 High Sec. Electromech. Safe Lock with 2740B Lock, Dial, Ring, Dust Cover, Change Key | \$1,936.63 |

PARTS & ACCESSORIES

| ORDER # | ITEM # | LIST |
|----------|---|----------|
| 735-2016 | SRG 2740-108 Dial Ring A & B Dial ring with attaching screws | \$263.45 |
| 735-2326 | SRG 2740-106 Dial/Spindle Assembly A & B (max 3.875" door thickness) | \$345.48 |

2740A Set Up Module

Alignment, operating mode selection, and diagnostics are performed with the aid of a plug-in setup module. This simple tool incorporates an easy-to-read graphic interface that facilitates lock installation, setting the operating mode, and performing normal service operations.



| ORDER # | ITEM # | LIST |
|----------|------------------------------------|----------|
| 735-2741 | SRG 2740-200 Plug-In Set Up Module | \$179.07 |

GOVERNMENT HARDWARE



2890B Pedestrian Door Locks

Built to the Requirements of Federal Specification FF-L-2890B

The 2890B provides both secure entry and life safety in one integrated solution. Compatible with both GSA approved combination locks, it provides the highest level of security to SCIFs used by U.S. agencies, the Department of Defense and defense contractors. Equipped with an interior panic bar or integrated Lever, it provides single motion egress at all times from within the SCIF.

TYPES I & II

- FF-L-2740B combination lock combined with a sturdy ADA compliant release handle on interior
- Secondary locking option: Access control system or mechanical keys



Egress view

| ORDER # | ITEM # | LIST |
|----------|---|------------|
| 735-3029 | SRG 2890-523 Type II PDPL EAC 3' Lever Handle w/ X10, #2 Strike | \$7,385.01 |
| 735-3030 | SRG 2890-523L Type II PDPL EAC 3' Lever Handle w/ X10, #3 Strike | \$7,585.01 |

TYPES III & IV

- Single-push panic bar combined with FF-L-2740B dial lock
- Secondary locking option: Access control system or mechanical keys



Egress view

| ORDER # | ITEM # | LIST |
|----------|---|------------|
| 735-3031 | SRG 2890-533M Type III PDLAP EAC 3' Panic Bar w/ X10, #2 Strike, Includes Alarm Integration Kit, RX Module | \$8,391.64 |
| 735-2331 | SRG 2890-543M Type IV PDLAP EAC 3' Panic Bar w/ X10, #2 Strike, Includes Alarm Integration Kit, RX Module | \$8,867.09 |
| 735-3033 | SRG 2890-543 Type IV PDLAP EAC 3' Panic Bar w/ X10, #2 Strike | \$8,018.09 |
| 735-3032 | SRG 2890-542M Type IV PDLAP EAC 3' Panic Bar w/ 2740B, #2 Strike, Includes Alarm Integration Kit, RX Module | \$7,363.21 |

ALARM INTEGRATION KIT

Gain the ability to monitor the complete status of the 2890B.

| ORDER # | ITEM # | LIST |
|----------|---|----------|
| 735-3039 | SRG 2890-640 Alarm Kit without Dial Rotation | \$849.00 |

2890B-500 Features

- Ships with one of the electromechanical combination locks that meet Federal Specification FF-L-2740B—S&G 2740B or X-10.
- Heavy-duty, surface mounted strike with integral roller for secure, smooth operation.
- Levers tested to 1M cycles and panic bar to 500K cycles for reliability and longevity.
- All six configurations are based on the same modular platform, providing a faster, standardized installation in facilities with multiple openings.
- 3-hour UL fire rating - highest in this market segment.
- NFPA 101 Life Safety, UL 305, BHMA, UL Fire 10B and 10C Certifications.
- The only lock that allows you to shelter in place during an active shooter situation and meets Federal Specification FF-L-2890B (when used with the S&G 2740B lock).
- **Five-year warranty when ordered and installed with the S&G Model 2740B Lock.** Two-year warranty when ordered and installed with an alternate lock.

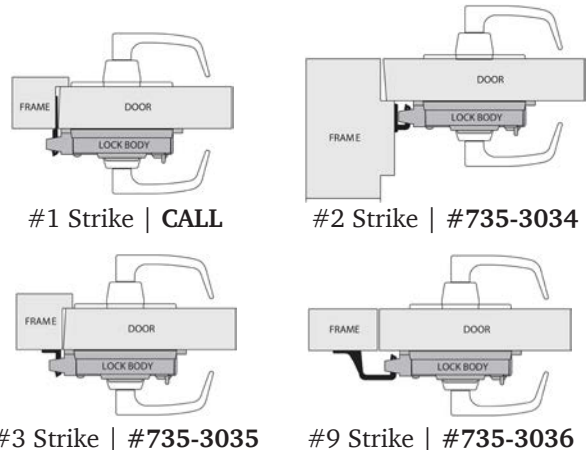

2890 STRIKES & PARTS

| ORDER # | ITEM # | LIST |
|----------|--|----------|
| 735-3034 | SRG 2890-602 #2 Strike | \$175.00 |
| 735-3035 | SRG 2890-603 #3 Strike | \$175.00 |
| 735-3036 | SRG 2890-609 #9 Strike | \$235.00 |
| 735-3037 | SRG 2890-615 Spacer Kit | \$146.83 |
| 735-3038 | SRG 2890-632 Narrow Exit Trim Plate Kit | \$483.61 |



SARGENT AND GREENLEAF®

GOVERNMENT HARDWARE

8497 Brute® Electronic Door Deadlatches

Built to the Requirements of Federal Specification FF-L-2890B

The S&G Brute lock is an extremely heavy-duty deadlatch lock for use in indoor applications, such as ATM rooms, cash handling areas, research laboratories, etc. Surface mounted for ease of installation and suitability for a wide range of applications, the Brute lock is fail secure and features an inside release knob for rapid egress. Great for safe rooms because they can be mounted on the inside surface of the door with nothing showing on the outside. Since it can be unlocked manually from the inside and it's a fail secure lock it's fire safety friendly for non public areas.

Brute® Features

- Surface mounted for ease of installation and suitability for a wide range of applications.
- Inside release knob provides for rapid egress.
- Strikes available for both inswing and outswing doors.
- An ideal security solution for indoor applications, such as ATM rooms, cash handling areas, research laboratories, etc.
- Originally designed to be used with the (discontinued) S&G Code/Tronic™ III access control device, The Brute® deadlatch can be used with any control device that meets its electrical requirements.
- The Brute® deadlatch uses a heavy duty 12 VDC solenoid. The 24 VDC voltage requirement increases bolt retraction force and will not harm the solenoid.



Electrical Specifications:

Required voltage: 24 VDC
 DC coil resistance: 6 OHMS
 Current: 5.5 to 6.5 AMPS
 Minimum recommended wire size: 18 gauge

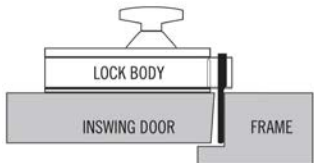

#1 Strike | #735-3471

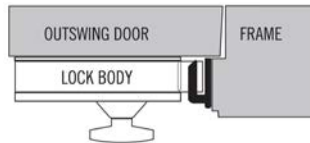

#2 Strike | #735-3472

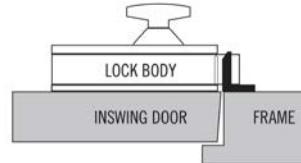

#3 Strike | #735-3473

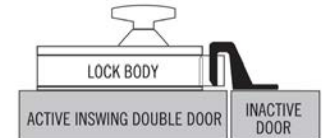

#9 Strike | #735-3474

8497 BRUTE LOCKS

| ORDER # | ITEM # | LIST |
|----------|--|----------|
| 735-2345 | SRG 8497-100 Brute Lock with #1 Strike for Inswing Doors | \$932.60 |
| 735-2346 | SRG 8497-101 Brute Lock with #2 Strike for Outswing Doors | \$943.26 |
| 735-3406 | SRG 8497-102 Brute Lock with #3 Strike for Inswing Doors | \$938.34 |
| 735-2332 | SRG 8497-103 Brute Lock with #9 Strike for Outswing Double Doors | \$986.90 |
| 735-3407 | SRG 8497-105 Brute Lock for Inswing Door, Less Strike | \$878.09 |
| 735-3408 | SRG 8497-106 Brute Lock for Outswing Door, Less Strike | \$878.09 |

STRIKES & PARTS

| ORDER # | ITEM # | LIST |
|----------|---|----------|
| 735-3404 | SRG 8497-006 Inswing Bolt | \$70.41 |
| 735-3405 | SRG 8497-007 Outswing Bolt | \$174.01 |
| 735-3471 | SRG 8497-001 #1 Strike for Inswing Doors | \$54.52 |
| 735-3472 | SRG 8497-002 #2 Strike for Outswing Doors | \$65.44 |
| 735-3473 | SRG 8497-003 #3 Strike for Inswing Door, Jamb Surf. Mount | \$60.56 |
| 735-3474 | SRG 8497-004 #9 Strike for Double Doors | \$109.63 |
| 735-2342 | SRG 8480-018-002-000 Pin Plunger | \$13.71 |

GOVERNMENT HARDWARE



2937 Model Group 1 Mechanical Safe Locks Built to the Requirements of Federal Specification FF-L-2937

The Model 2937 lock represents the latest design advances to produce a mechanical lock to secure certain types of GSA approved containers, such as field safes, armory vault doors, weapons containers and similar items. The Model 2937 lock is a UL Group 1 lock designed to meet Federal Specification FF-L-2937 and is built to provide a high level of security for government and defense industry applications. Along with a key changeable wheel design for simple combination changing, the 2937 incorporates S&G's patented, time-tested torque adjuster to allow precise setting and maintenance of wheel pack torque.

- Underwriters Laboratories Listed Group 1.
- Stainless steel bolt withstands a minimum of 600 lbs. of side and end load.
- Dial spindle incorporates carbide barrier pins and a shear line to control the point of separation in a forced entry attempt.
- Three all metal wheels provide for 1,000,000 unique theoretical combinations.
- Resistance to expert manipulation tested and verified by Underwriters Laboratories to exceed 20 man-hours.
- Built to provide a high level of security for government and defense industry applications.
- Internal relock trigger secures the lock in the event of a burglar's punch attack.
- Integral thermal relock component protects against thermal attacks.
- Two-way drive cam and two-way dial spindle combine to allow mounting right-hand, left-hand, vertical-up, or vertical-down.
- Uses a standard S&G 3-wheel change key (U8 or U9).

2937 MECHANICAL SAFE LOCKS

| ORDER # | ITEM # | LIST |
|----------|--|----------|
| 735-2937 | SRG 2937-200 Complete Lock with Dial, Ring, 3.616 Spindle, Dust Cover, Additional Bolt for Mosler, Accessory Pack, and Docs. | \$729.13 |
| 735-3040 | SRG 2937-001 Lock Only | \$508.51 |



PARTS & ACCESSORIES

| ORDER # | ITEM # | LIST |
|----------|---------------------------------|---------|
| 735-2017 | 2937-003 Dial Ring & Dust Cover | \$61.42 |

ALSO AVAILABLE Continental Access

Cypher Lock Military Type CodeTronic System

An extra heavy duty electronic push-button Access Control system that permits entry only to those who know its correct 4-digit code. This is the same system that has been very popular with government agencies and the military for many years. There are no keys to issue; no cards to buy and replace. You program the entry code in just seconds and inform only authorized personnel of the combination.

- Adjustable "door open" time.
- Adjustable "wrong code penalty time out."
- Error alarm to expose guessers.
- Request to exit terminals to unlock from inside.
- Can power directly electric strikes from 6, 12 or 24 volts either AC or DC



**MANY OPTIONS AVAILABLE
CALL US TO ORDER!**



SARGENT AND GREENLEAF®

GOVERNMENT HARDWARE

Extension 50 Mechanical Automatic Door Deadbolt Three-wheel combination lock, 1 million different combinations

Extension 50 Features

- Surface mounted
- Automatic locking deadbolt mechanism incorporates an inside release knob for rapid egress, and a manual “dogging” switch to keep the device unlocked when the secured area is occupied.
- Strikes available for both inswing and outswing doors.
- Equipped with either an 8400 or 8500 Series Group 1 or Group 1R combination lock for a high level of security.
- An ideal security solution for indoor applications, such as ATM rooms, cash handling areas, research laboratories, etc.
- All units include a rectangular hardplate that is placed under the mounting plate to deter forced entry attacks.
- Interlocking strike (any model) prevents spreading of the door and frame.
- Hardened steel pins inside the locking bolt deter sawing and increase forced entry resistance.

#1 Strike | #735-3471
 List \$54.52

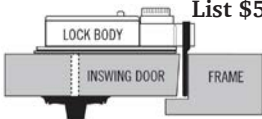

#2 Strike | #735-3472
 List \$54.52



#3 Strike | #735-3473
 List \$60.56

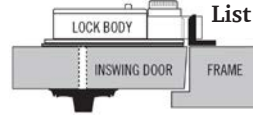

#9 Strike | #735-3474
 List \$109.63



| ORDER # | ITEM # | LIST |
|----------|---|------------|
| 735-3410 | SRG 8555-102 Automatic Door Deadbolt with Tube, Group 1, #2 Strike, D054/R162, B&W | \$1,592.14 |
| 735-3470 | SRG 8415-107 Automatic Door Deadbolt with Tube, Group 1, Less Strike, 3.4” Door, D041/R162, B&W | \$1,557.80 |



1881 Sliding Mechanical Deadbolts

Full 1" bolt throw. Both models can be secured in the locked or unlocked position. Surface mount design with hardened steel bolt pins resist sawing and over one ton of thrust. The 1881 model will accept any 5/16" (8 mm) diameter shackle padlock, such as the S&G 8077AD. The 1883 model incorporates a 4-pin tumbler cylinder operated by keys cut on National D4291 blanks.



#12 Strike | #735-3012

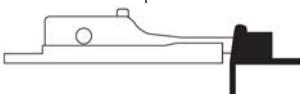

#13 Strike | #735-3013

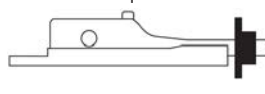

#14 Strike | #735-3014

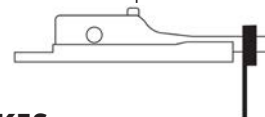

#15 Strike | #735-3015

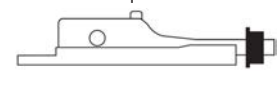

SLIDING DEADBOLTS

| ORDER # | ITEM # | STRIKE | LIST |
|----------|------------------|--------|----------|
| 735-3000 | SRG 1881-001 NKL | Less | \$131.37 |
| 735-3025 | SRG 1881-002 NKL | #12 | \$179.12 |
| 735-3026 | SRG 1881-003 NKL | #13 | \$179.12 |
| 735-3027 | SRG 1881-004 NKL | #14 | \$179.12 |
| 735-2347 | SRG 1881-005 NKL | #15 | \$179.12 |
| 735-3002 | SRG 1883-001 KL | Less | \$158.62 |

NKL = Non-Key Locking KL = Key Locking

STRIKES

| ORDER # | ITEM # | LIST |
|----------|--|---------|
| 735-3012 | SRG 1810-001 #12 Strike Double Door Strike, Use with 1881 & 1883 Deadbolts | \$43.84 |
| 735-3013 | SRG 1810-002 #13 Strike Mortise Floor Strike, Use with 1881 & 1883 Deadbolts | \$43.84 |
| 735-3014 | SRG 1810-003 #14 Strike Surface Mount Strike for Standard Door, Use with 1881 & 1883 Deadbolts | \$43.84 |
| 735-3015 | SRG 1810-004 #15 Strike Mortise Frame Strike, Use with 1881 & 1883 Deadbolts | \$43.84 |

MECHANICAL SAFE LOCKS



6730/6731 SERIES Group 2 Mechanical Safe Locks

The 6730 Series is designed and constructed to perform on gun safes, bank locks and the most demanding commercial applications. With more than two hours of manipulation resistance and 1,000,000+ theoretical combinations to combat auto-dialers, it is widely recognized as the standard Group 2 lock of the industry.

6730 Series: UL Group 2, three-wheel – brass

6731 Series: UL Group 2, four-wheel – brass

Features

- Three brass and aluminum wheels provide 1,000,000 theoretical combinations. Four-wheel 6731 model offers 100,000,000 theoretical combinations.
- Made to outperform other locks in the most demanding commercial applications.
- Internal relock trigger secures the lock in the event of a burglar's punch attack.
- 4-way drive cam for mounting right-hand, left-hand, vertical-up, or vertical-down.



LOCK BODIES AND DIALS/RINGS

| ORDER # | ITEM # | LIST |
|----------|--|----------|
| 735-2008 | SRG 6730-100 Mech. Safe Lock Bolt, D300 Dial, R211 Ring, B&W | \$140.45 |
| 735-2123 | SRG 6730-101 Mech. Safe Lock Bolt, D003 Dial, R004 Ring, B&W | \$140.45 |

BOLTS

| ORDER # | ITEM # | DESC. | LIST |
|----------|------------------|----------------------------|---------|
| 735-2176 | SRG 6730-003-069 | 1.273" Solid End, No Holes | \$26.29 |
| 735-2177 | SRG 6730-003-070 | 2.273" Bolt | CALL |
| 735-2178 | SRG 6730-003-073 | 1.164" Bolt | \$26.62 |
| 735-2179 | SRG 6730-003-074 | 1.77" Bolt | \$35.96 |
| 735-2180 | SRG 6730-003-122 | 3.062" Bolt | CALL |
| 735-2181 | SRG 6730-003-125 | 2.531" Bolt | CALL |
| 735-2182 | SRG 6730-003-138 | 2" Bolt | CALL |
| 735-2183 | SRG 6730-003-140 | 3.273" Bolt | \$77.93 |
| 735-2184 | SRG 6730-003-150 | 1.273" Bolt | \$31.74 |
| 735-2185 | SRG 6730-003-152 | 5" Utility Bolt | CALL |
| 735-2186 | SRG 6730-003-167 | 1.164" Mosler Bolt | \$79.89 |
| 735-2187 | SRG 6730-003-180 | 1.273" Bolt | \$42.27 |
| 735-2188 | SRG 6730-003-206 | 1.273" Bolt | CALL |

LOCK BODIES ONLY

| ORDER # | ITEM # | LIST |
|----------|--|----------|
| 735-2009 | SRG 6730-010 Mech. Lockbody 3 Wheel Pack | \$119.37 |
| 735-2124 | SRG 6731-004 Mech. Lockbody 4 Wheel Pack | \$146.44 |

PARTS & ACCESSORIES

| ORDER # | ITEM # | LIST |
|----------|---|---------|
| 735-2035 | SRG D300-018 Front Reading Large Knob Dial for 6700 Lock and R211 Ring, B&W | \$26.28 |
| 735-2171 | SRG 6720-005-512 Drive Cam Assembly | \$24.38 |
| 735-2172 | SRG 6720-085-001 3 Wheel Lever Screw | \$4.50 |
| 735-2173 | SRG 6720-102-004 Lever Spring (10/pk) | \$3.85 |
| 735-2174 | SRG 6721-004-502 4 Wheel Lever Assembly, Brass | \$18.73 |
| 735-2175 | SRG 6721-085-001 4 Wheel Lever Screw | \$4.50 |



MECHANICAL SAFE LOCKS

6741 SERIES Group 2 Mechanical Safe Locks

Three die cast Zamak and aluminum wheels provide 1,000,000 theoretical combinations. Die cast push-pull Lever with wider dialing tolerances makes the lock easy to dial and less sensitive to bolt side and end pressure than standard Levers.

- UL Group 2 Listed
- Internal Relock Trigger
- Chromated Zamak Lever
- 3 Zamak and aluminum wheels
- Stamped Brass Flys
- Single-Locking Wheel Mechanism
- Wave Washer Torque Adjuster
- 620L Clear Coat on Case
- Four-way drive cam

LOCK BODY WITH DIAL

| ORDER # | ITEM # | LIST |
|----------|---|----------|
| 735-0045 | SRG 6741-106 Mech. Safe Lock with bolt, D300/R211, B&W, 3 Wheel | \$126.95 |

PARTS & ACCESSORIES

| ORDER # | ITEM # | LIST |
|----------|--------------------------------------|--------|
| 735-2192 | SRG 6740-102-005 Lever Spring, LH | \$3.85 |
| 735-2193 | SRG 6740-163-002 Spring Ball Detent. | \$2.59 |



6630 Group 2M Mechanical Safe Locks

The 6630 Series is designed and constructed to perform in ATMs and the most demanding commercial applications. These locks use the 6730 lock design—but with added security features such as false wheel gates and an eccentric roller in the Lever nose. With more than two hours of manipulation resistance, you can be assured your cash assets are secure and you'll have years of problem-free performance.

6630 Features

- Three brass and aluminum combination wheels provide 1,000,000 theoretical combinations. The four-wheel 6631 Series provides 100,000,000 theoretical combinations.
- Designed and constructed to perform in the most demanding commercial applications.
- Internal relock trigger secures the lock in the event of a burglar's punch attack.
- Four-way drive cam allows mounting right-hand, left-hand, vertical-up, or vertical-down.



| ORDER # | ITEM # | LIST |
|----------|--|----------|
| 735-2122 | SRG 6630-010 Mech. Lockbody Complete Group 2M Safe Lock, Standard Lock Bolt, 3 Wheel | \$127.31 |

MECHANICAL SAFE LOCKS

SARGENT AND GREENLEAF®

8410 SERIES Group 1 Manipulation Proof® Mechanical Safe Lock

The 8400 Series is designed for use in government applications such as the postal service as well as high-value safes. These three-wheel locks provide mechanical durability and over 1 million possible combinations for superior, long-lasting security.



8410 Features

- Tested and verified by Underwriters Laboratories to resist 20 man-hours of expert manipulation.
- Three combination wheels (made of brass and aluminum or acetal resin) offer 1 million theoretical unique combinations.
- Designed and constructed to perform in the most demanding applications.
- Internal relock trigger secures the lock in the event of a punch attack.
- Using a Centi-Spline dial, the lock can be mounted right-hand, left-hand, vertical-up, or vertical-down

LOCK BODY WITH DIAL

| ORDER # | ITEM # | LIST |
|----------|---|----------|
| 735-3403 | 8410-100 Mech. Safe Lock D041/R162, B&W, Spy-Proof | \$484.14 |

PARTS & ACCESSORIES

| ORDER # | ITEM # | LIST |
|----------|--|---------|
| 735-2030 | D041-010 Spy-Proof Dial & Ring Only D041/R162, B&W, Spy-Proof | \$99.14 |
| 735-2190 | SRG 6740-004-506 Lever Assembly, 8400MP Locks, Brass | \$25.94 |
| 735-2191 | SRG 6740-085-000 8400 Lever Screw for 8400MP Locks | \$4.50 |

8550 Group 1 and 8560 Group 1R Mechanical Safe Locks Three-wheel combination lock, manipulation resistant

Tested against expert manipulation and designed with three combination wheels for 1,000,000 possible combinations, you can count on the 8500 Series to provide the higher security you need.

Features

- 8550 Series: Underwriters Laboratories Listed Group 1, VdS Class 2, CEN B, DNV 3492, CNPP A2P B/E.
- 3 wheels provide 1 million theoretical combinations.
- Manipulation resistance tested and verified to exceed 20 man-hours.
- The 8560 Series has also been tested against 20 man-hours of radiological imaging attacks by Underwriters Laboratories.
- Internal relock trigger secures the lock in the event of a burglar's punch attack.
- Mount RH, LH, vertical-up, or vertical-down.

| ORDER # | ITEM # | LIST |
|----------|---|----------|
| 735-2006 | SRG 8550-100 Group 1 Mech. Lock D054 Dial & R162 Ring, B&W, Spy-Proof | \$373.62 |
| 735-3479 | SRG 8550-003 Group 1 Combo Lockbody Only | \$298.32 |
| 735-3411 | SRG 8560-100 Group 1R Mech. Lock D054 Dial & R162 Ring, B&W, Spy-Proof | \$397.71 |
| 735-3409 | SRG D054 Dial & R162 Ring Only, B&W, Spy-Proof for both 8550 and 8560 Series Locks | CALL |





SARGENT AND GREENLEAF®

KEY OPERATED SAFE LOCKS

6804/6824 Key-Op® Key Operated Safe Locks

Key retaining locks operated by single-bitted (6804) and double-bitted keys (6824). Ideal for small, lightweight safes, as well as interior locking compartments. They're also commonly used as secondary locks on high-security safes.

KEY-OP LOCKS WITH KEYS

| ORDER # | ITEM # | LIST |
|----------|--|----------|
| 735-2126 | SRG 6804-049 Key Operated Safe Lock Single Bit, Key Retaining, 2 Keys and 1 Escutcheon | \$127.88 |
| 735-6804 | SRG 6824-005 Key Operated Safe Lock Double Bitted, Key Retaining, 2 Keys and 1 Escutcheon | \$125.61 |



KEYS & PARTS

| ORDER # | ITEM # | LIST |
|----------|--|---------|
| 735-2197 | SRG 6804-017 Square Head Cut Keys (2/pk) | \$51.89 |
| 735-2198 | SRG 6804-019 Single Bit Key Blank, Un-cut | \$25.27 |
| 735-2199 | SRG 6804-019 Single Bit Key Blank, Cut to Code | CALL |
| 735-2200 | SRG 6804-021 Key Blank, 1.5" D.T. | \$20.74 |
| 735-2196 | SRG 6804-009 Escutcheon, Nickel | \$9.08 |
| 735-2202 | SRG 6804-033 Escutcheon, Chrome | \$38.04 |

6870 SERIES Key Operated Safe Locks

Opposing Lever design for a higher level of security and pick resistance. Most of the models can be configured to your needs and specific application. These locks are ideal for small, lightweight safes, as well as interior locking compartments. They're also commonly used as secondary locks on high-security safes.

LOCK BODY ONLY

| ORDER # | ITEM # | LIST |
|----------|---|---------|
| 735-2127 | SRG 6870-092 FAS Lock Lockbody Only, No Keys | \$99.30 |



KEYS & PARTS

| ORDER # | ITEM # | LIST |
|----------|--------------------------------------|---------|
| 735- | SRG 6870-100 Key Blank, 45MM | \$12.94 |
| 735-2343 | SRG 6870-130 Key Blank, 115 MM | \$17.28 |
| 735-2205 | SRG 6870-132 Random Cut Keys* (2/pk) | \$46.68 |
| 735-2206 | SRG 6870-133 Random Cut Keys* (3/pk) | \$69.00 |
| 735-2207 | SRG 6870-134 Random Cut Keys* (4/pk) | \$91.40 |

| ORDER # | ITEM # | LIST |
|----------|--|---------|
| 735-2208 | SRG 6870-200 Removable Stem for FAS, 210MM | \$62.14 |
| 735-2209 | SRG 6870-201 Detachable Bit for 6870- 200, Uncut | \$20.19 |
| 735-2210 | SRG 6870-202 Random Cut Bits, KA for Rem. Stem (2/pk) | \$46.67 |
| 735-2211 | SRG 6870-204 Random Cut Bits, KA for Rem. Stem (4/pk) | \$91.40 |
| 735-2212 | SRG 6870-310 1 Piece Escutcheon | \$17.36 |

* for 4.22" max. door thickness

MECHANICAL VAULT LOCKS



6500 SERIES Mechanical Vault Locks

LOCKS WITH BOLTS

| ORDER # | ITEM # | LIST |
|----------|--|----------|
| 735-2120 | SRG 6530-001 Group 2 Mech. Vault Lock Center Ext. Bolt, Reversible, Direct Drive, Field Config LH or RH | \$525.82 |
| 735-2121 | SRG 6530-002 Group 2 Mech. Vault Lock Roller Bolt, Reversible, Direct Drive, Field Config LH or RH | \$528.82 |



Pictured with Conversion Kit

PARTS & ACCESSORIES

| ORDER # | ITEM # | LIST |
|----------|--|----------|
| 735-2162 | SRG 6500-003-001 Roller Bolt | \$79.29 |
| 735-2163 | SRG 6500-003-002 Square End Bolt | \$114.12 |
| 735-2164 | SRG 6500-003-003 Bolt Center Extension | \$184.05 |
| 735-2165 | SRG 6500-003-004 Bolt Extension Upper and Lower Extension, Satin Nickel | \$232.27 |
| 735-2167 | SRG 6524-001 Indirect Drive Conversion Kit | \$275.18 |
| 735-2216 | SRG 7312-002 Spindle Ext Kit 3/8 X 30 Thread 4.900" for 6500 Series | \$37.22 |

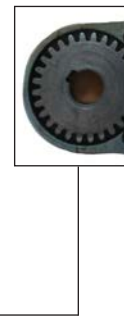

DRILL BITS

PRO-LOK

Hardplate Drill "Butter" Bits As easy as drilling through butter!



- Designed for safes & drilling difficult material such as concrete and stainless steel
- Tungsten carbide with **diamond ground tips**
- Unique negative rake angle and shortened chisel edge that increases effectiveness and reduces tip failure
- Fast starting & faster cutting
- Hardened shanks

| ORDER # | ITEM # | DIMENSIONS | PRICE |
|----------|----------|------------|---------|
| 684-0500 | PRO SB05 | 1/4" x 4" | \$18.78 |
| 684-0505 | PRO SB06 | 1/4" x 6" | \$18.50 |
| 684-0510 | PRO SB11 | 5/16" x 5" | \$23.00 |
| 684-0515 | PRO SB12 | 5/16" x 8" | \$23.60 |
| 684-0520 | PRO SB15 | 3/8" x 5" | \$29.48 |
| 684-0525 | PRO SB16 | 3/8" x 8" | \$31.60 |
| 684-0530 | PRO SB17 | 3/8" x 12" | \$39.00 |
| 684-0535 | PRO SB20 | 1/2" x 6" | \$36.98 |



SARGENT AND GREENLEAF®

DIALS, RINGS, & PARTS

DIALS

| ORDER # | ITEM # | DESC. | LIST |
|----------|----------------------|----------------------------------|----------|
| 735-2024 | SRG D003-003 FR Dial | OBW 3.406 (50) S&G | \$30.92 |
| 735-2025 | SRG D022-004 SP Dial | OBW 3.406 (50) NNO | \$36.09 |
| 735-2026 | SRG D022-009 SP Dial | OSC 3.406 (50) S&G | \$43.84 |
| 735-2027 | SRG D023-020 SP Dial | OBW 12.00 (60) S&G | \$59.14 |
| 735-2029 | SRG D037-002 Dial | OBW 3.406 (39) S&G | CALL |
| 735-2030 | SRG D041-010 SP Dial | OSC 3.406 (50) S&G | \$99.14 |
| 735-2031 | SRG D052-005 SP Dial | OBW 3.406 (19) NNO | \$53.88 |
| 735-2032 | SRG D054-004 SP Dial | OBW 3.406 (19) Dual-Splined, NNO | \$46.78 |
| 735-2034 | SRG D112-002 SP Dial | OBW 3.406 (50) S&G | \$102.15 |
| 735-2036 | SRG D220-014 SP Dial | OBW 3.406 (50) S&G | \$33.66 |
| 735-2037 | SRG D220-017 SP Dial | OSC 3.406 (50) S&G | \$39.75 |
| 735-2038 | SRG D220-105 SP Dial | OBW 10.00 (50) S&G | \$52.69 |
| 735-2053 | SRG D220-182 SP Dial | OBW 6.00 (50) S&G | \$46.96 |
| 735-2054 | SRG D220-200 SP Dial | OSC 12.50 (50) NNO | \$70.68 |
| 735-2055 | SRG D225-008 SP Dial | OBW 3.406 (41) S&G KD | \$62.95 |
| 735-2056 | SRG D225-014 SP Dial | OSC 3.406 (41) S&G KD | \$70.02 |
| 735-2057 | SRG D225-177 SP Dial | OBW 7.500(50) S&G KD | \$77.52 |
| 735-2058 | SRG D230-011 SP Dial | OBW 6.500 (60) S&G | \$36.77 |
| 735-2059 | SRG D230-013 SP Dial | OSC 6.500 (60) S&G | \$42.40 |
| 735-2060 | SRG D230-052 SP Dial | OBW 10.00 (60) S&G | \$48.74 |
| 735-2061 | SRG D240-003 SP Dial | OBW 6.500 (60) S&G KD | \$69.23 |
| 735-2063 | SRG D300-021 FR Dial | OSC 3.406 (41) S&G | \$32.69 |
| 735-2064 | SRG D300-057 FR Dial | OBW 10.00 (50) S&G | \$40.17 |
| 735-2065 | SRG D300-140 | 6.5" Spindle-Special | CALL |
| 735-2035 | SRG D300-18 FR Dial | Large Knob for 6700 Lock, B&W | CALL |
| 735-2066 | SRG D540-019 SP Dial | OSC 10.00 (19) S&G | \$79.27 |
| 735-2067 | SRG D541-043 | 12" Spindle OSC | CALL |
| 735-2070 | SRG D690-007 FR Dial | OBW 3.406 (41) S&G KD | \$57.92 |
| 735-2071 | SRG D690-047 | 0.500 DT OBW NNO Logo | CALL |



D003 with R004

D041 with R162

D054 with R162

D112 with R162

D220 with R167

D225 with R167

D300 with R211

D540 with R167

D690 with R211



SAFE LOCKS



DIALS, RINGS, & PARTS



SARGENT AND GREENLEAF®

RINGS

| ORDER # | ITEM # | DESC. | LIST |
|----------|----------------------------|---------------------------|----------|
| 735-2015 | SRG R004-002 FR Ring | OBW Dial Ring | \$17.75 |
| 735-2075 | SRG R034-002 FR Ring | OBW Ring, Small Dia. | \$21.23 |
| 735-2076 | SRG R132-019 KL Dial Ring | OBW Ring, KD | \$109.84 |
| 735-2077 | SRG R132-020 KL Dial Ring | OSC Dial Ring, KD | \$123.29 |
| 735-2019 | SRG R162-002 SP Ring | OBW Dial Ring | \$23.31 |
| 735-2078 | SRG R162-004 SP Ring | OSC Dial Ring | \$29.63 |
| 735-2020 | SRG R167-002 SP Ring | OBW Dial Ring | \$22.31 |
| 735-2080 | SRG R167-014 SP Ring | OSC Dial Ring | \$28.46 |
| 735-2081 | SRG R167-025 SP Brass Ring | OBB Dial Ring | \$31.34 |
| 735-2082 | SRG R174-001 SP Ring | KL Dial Ring | \$13.15 |
| 735-2083 | SRG R187-002 24K Gold Ring | Day Lock (Open/Closed) | CALL |
| 735-2022 | SRG R211-002 FR Ring | OBW Dial Ring, Large Knob | \$16.52 |
| 735-2087 | SRG R211-004 | FR Ring | \$21.65 |
| 735-2088 | SRG R211-006 | OSN Ring | CALL |
| 735-2090 | SRG R212-001 | FR Ring with SP Cover | CALL |
| 735-2091 | SRG R214-002 FR Ring | KL Dial Ring (5/16 SC) | \$13.20 |

PARTS

| ORDER # | ITEM # | LIST |
|----------|--|---------|
| 735-2150 | SRG 2636-002 Safe Handle 1/2" | CALL |
| 735-2151 | SRG 2636-028 Round Hub OBB Safe | CALL |
| 735-2155 | SRG 6242-005 Winding Key | \$29.96 |
| 735-2156 | SRG 6242-411-002 Filler Block | \$38.53 |
| 735-2160 | SRG 6253-020-002 Plastic Window Magnify for Time Lock | \$31.59 |
| 735-2161 | SRG 6260-000-001 Winding Chart for Time Lock | \$52.16 |
| 735-2217 | SRG 7312-003 Extension Kit for 6700 Series Dial; 5/16" Diameter, 6" Length | \$37.22 |
| 735-2214 | SRG 7051-019-001-000 Washer f or D54 | \$2.59 |
| 735-2215 | SRG 7051-076-001-000 Spring for D54 | \$2.59 |
| 735-2218 | SRG 7600-001 Dust Cover (Conv) | CALL |
| 735-2219 | SRG 7600-002 Dial Bearing Insert | \$2.39 |
| 735-2220 | SRG 7600-003 Key Locking Logo | \$6.06 |
| 735-2221 | SRG 7600-004 Non Key-Locking Logo | \$3.55 |
| 735-2222 | SRG 7600-005 Cylinder Insert KD | \$35.45 |
| 735-2223 | SRG 7600-006 Cylinder Insert KA | \$35.43 |
| 735-2224 | SRG 7600-090-001 Blank Logo NKL | \$4.68 |



SARGENT AND GREENLEAF®

DIALS, RINGS, & PARTS

PARTS

| ORDER # | ITEM # | LIST |
|----------|--|----------|
| 735-2225 | SRG 7700-020 Magnetic Mech Comb Dial Light | \$36.55 |
| 735-2226 | SRG 7700-021 Elec. Keypad Light | \$36.55 |
| 735-2229 | SRG 8480-355-502 Solenoid MEB 16 x 2 | \$312.34 |
| 735-2233 | SRG 8550-005-505 2 Way Drive Cam Assembly | \$53.14 |
| 735-2234 | SRG 8550-102-001 Lever Spring | \$5.08 |
| 735-2235 | SRG 8555-002-510 SMR Cover, Black | \$109.10 |
| 735-2236 | SRG 8700-108-011 Short Attaching Screw | \$2.59 |
| 735-2237 | SRG 9057-002 8500 Plastic Wheel Back | \$142.97 |
| 735-2238 | SRG 9057-030-068 Top Fly | \$6.33 |
| 735-2239 | SRG 9057-030-086 MP Top Fly | \$6.09 |
| 735-2240 | SRG 9057-031-002 Mid/Bot Fly | \$5.15 |
| 735-2243 | SRG 9060-001 Wheel Pack | \$145.15 |
| 735-2244 | SRG 9068-001 6500 Wheel Pack | \$221.71 |
| 735-2245 | SRG 9068-004 Bridge Assembly w/ Wheels | \$358.50 |
| 735-2247 | SRG E5 Accessory Pack for 8500 Lock | CALL |
| 735-2248 | SRG F5 Accessory Pack | CALL |
| 735-2249 | SRG N9-001 | CALL |
| 735-2250 | SRG Spring for U22 Drive Cam | CALL |
| 735-2251 | SRG U11 6500 Change Key | \$47.70 |
| 735-2252 | SRG U12 6700 4 Wheel Change Key | \$12.80 |
| 735-2253 | SRG U14 Inner Spindle | \$23.90 |
| 735-2254 | SRG U17 6700 Spline Key | \$1.72 |
| 735-2255 | SRG U18 8400 Spline Key | \$2.39 |
| 735-2256 | SRG U19 6500 Spline Key | \$4.18 |
| 735-2257 | SRG U22 8400 Drive Cam | \$184.12 |
| 735-2258 | SRG 1/2 Oz. Portion AS22 Lube | CALL |
| 735-2259 | SRG U24 Tube Kit | \$15.02 |
| 735-2260 | SRG U8 Standard Change Key | \$12.80 |
| 735-2261 | SRG U9 Extra Long 8400/6700 Change Key | \$14.36 |
| 735-2318 | SRG 000-338-112 Retaining Ring | CALL |
| 735-2321 | SRG 0000-402-110-ONI Cover Screw | CALL |
| 735- | SRG 0000-636-152 "Protected" Label | CALL |
| 735-2323 | SRG 0000-636-193 "Slamming" Label | CALL |
| 735-2327 | SRG 4543 Cam | CALL |

**SOUTHERN LOCK
EXCLUSIVE**

SERVICE KITS

Service Kit for S&G Safe Locks for 6730, 6735, 6738, 6741 Series

- A522-Lube
- .012 Spacing Isolation Washer "Middle"
- .018 Spacing Isolation Washer "Bottom"
- Spirlock Wheel Retaining Ring
- Spring Detent
- Ball Detent
- Spline Keys
- Dial Ring Screws
- Standard Lock Mounting Screws
- Lever Spring (6720 Series)
- Lock Back Cover Screws
- Dial Ring Bearing
- Wheel Pack Kit (6730, 6735, 6738, 6741 Series)
- Extra Long Bolt (Cut to Fit)
- Standard Bolts
- 6700 Series Lever Screws
- Wavy Washer Bottom of Wheel Pack on 6741
- Keyed Cylinder for Dial
- Dial Cover for Cylinder
- Dial Cover Blank
- Ball Detent
- Lock Back Cover Screws
- Spline Keys
- Dial Ring Bearing
- U8 3-Wheel Change Key
- U12 4-Wheel Change Key

CALL TO ORDER

DIALS, RINGS, & PARTS

PARTS FOR 6730, 6735, 6738, 6741 SERIES

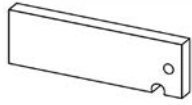

#735-2183 | Extra Long Brass Bolt | List \$77.93
 Extends 2.461" from end of lock case when locked, 2.109" from case when unlocked.

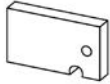

#735-2179 | Long Brass Bolt | List \$35.96
 Extends 0.961" from end of lock case when locked, 0.609" from case when unlocked.



#735-2176 | Standard Brass Bolt | List \$26.29
 Extends 0.461" from end of lock case when locked, 0.109" from case when unlocked.



FACTORY ORDER | Metric Tapped Brass Bolt
 Extends 0.461" from end of lock case when locked, 0.109" from case when unlocked. Bolt is drilled and tapped to a depth of 10 mm for two 4 mm - 7 pitch machine screws.



#735-2186 | Short Tapped Brass Bolt (also for 2937 Series) | List \$79.89
 Extends 0.352" from end of lock case when locked. Retracts flush to lock case. Bolt is drilled and tapped to a depth of 3/8" for two 10-32 machine screws.
 * Stainless steel also available by factory order

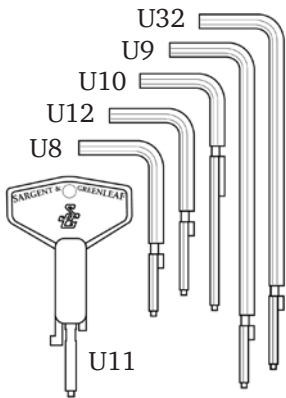

FACTORY ORDER | U32 Long Four Wheel Change Key
 Long handle change key for all standard size locks with four wheels.

#735-2261 | U9 Long Three Wheel Change Key | List \$14.36
 Long handle change key for all standard size locks with three wheels.

FACTORY ORDER | U10 Timebination Change Key
 For all Timebination time delay locks with three wheels.

#735-2252 | U12 Standard Four Wheel Change Key | List \$12.80
 Regular change key for all standard size locks with four wheels.

#735-2260 | U8 Standard Three Wheel Change Key | List \$12.80
 Regular change key for all standard size locks with three wheels.

#735-2251 | U11 Vault Lock Change Key | List \$47.70
 Regular change key for all S&G® vault locks with four wheels made after 1956.

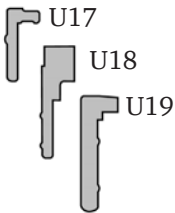

#735-2254 | U17 Standard Spline Key | List \$1.72
 For 6700 & 8500 Series locks.

#735-2255 | U18 Spline Key | List \$2.39
 For 8400 Series locks.

#735-2256 | U19 Vault Lock Spline Key | List \$4.18
 For 6400 & 6500 Series vault locks after 1956.



#735-2219 | Dial Ring Bearing | List \$2.39
 The Delrin® bearing inserts into the back of all S&G dial rings (except when used with D112 dials) to provide a bearing surface for the dial as it rotates within the ring.

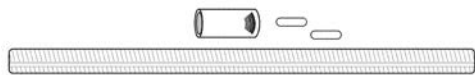

#735-2217 | Spindle Extension Kit | List \$37.22
 For locks using 5/16"-40 x 6" spindles. Kit includes a .450" dia. collar, Spindle, extension collar, and spline keys are included in the kit.
 * Also available in 3/8"-30 x 7" kit with .510" diameter collar for mechanical vault locks - factory order



#735-2243 | Wheel Pack | List \$145.15
 Brass and aluminum wheel pack for 2937, 6730, 8400, and 8500 series locks. Includes flies and spacer washers. Two top flies are also included, one pointed for use in 8400 locks and a standard top fly for all other locks.

//////////////////// **DIALS, RINGS, & PARTS** //////////////////////
FOR 6730, 6735, 6738, 6741 SERIES MECHANICAL COMBINATION LOCKS

 #735-2254 | U17 Spline Key | List \$1.72

 #735-2171 | Four Way Drive Cam | List \$24.38

 #735-2318 | Spirolox Wheel/Retaining Ring | List \$2.49

 #735-2238 | Top Fly | List \$6.33

 #3 Wheel (Same as #2 Wheel)

 #735-3475 | .012 Spacing/Isolation Washer | List \$5.08

 #735-2240 | #2 Wheel Fly (Same as #1 Fly) | List \$5.15

#735-2243 | Wheel Pack
 List \$145.15

 #2 Wheel (Same as #3 Wheel)

 #735-3475 | .012 Spacing/Isolation Washer | List \$5.08

 #735-2240 | #2 Wheel Fly (Same as #1 Fly) | List \$5.15

 #1 Wheel

 #735-3476 | .018 Spacing/Isolation Washer | List \$5.08

 Torque Adjuster

#735-2321 | Roll Forming Cover Screws
 fit all Group 2 Locks (pk/10)
 List \$8.20 pk/10

 #735-2172 | Lever Screw
 List \$4.50





 Lever

 #735-2173 | Lever Spring
 List \$3.85

 Relock Trigger Lever

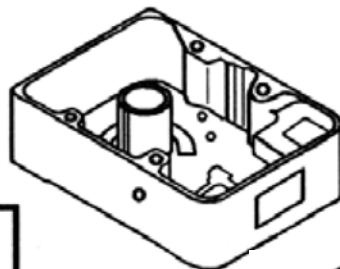
 Relock Lever Spring



 #735-2176 | Standard Bolt
 List \$26.29

 #735-3477 | 3/16" Ball | List \$1.92

 #735-3478 | Ball Spring | List \$2.00

 Relock Lever Stud



DIALS, RINGS, & PARTS

PARTS FOR 6730, 6735, 6738, 6741 SERIES

KEY CYLINDERS

Disc tumbler cylinder for rekeying or repairing key locking, convertible style dials, or to convert nonkey locking dials to the key locking function. Uses a standard Y13 keyway and five brass discs. When the cylinder is pushed into the dial, a spring-loaded brass retainer snaps into position to hold the cylinder in place. Separate insert available for conversions. Two keys per cylinder.



| ORDER # | DESCRIPTION | LIST |
|----------|-------------------------------|---------|
| 735-2222 | Key Cylinder for KD Cylinders | \$35.45 |
| 735-2223 | Key Cylinder for KA Cylinders | \$35.43 |

Keyblank for Wafer Tumbler Dial Lock Cylinder

| ORDER # | DESCRIPTION | LIST |
|----------|-------------|--------|
| 735-7600 | 7600-070-KB | \$2.00 |



**DISCONTINUED!
GONE WHEN GONE**

DIAL RINGS

Metallic, self-stick inserts are used with all large knobs, convertible S&G dials.



#735-2220



#735-2221

| ORDER # | DESCRIPTION | LIST |
|----------|------------------------------------|--------|
| 735-2220 | For knobs & dials with cylinder | \$6.06 |
| 735-2221 | For knobs & dials without cylinder | \$3.55 |



SAFE DEPOSIT HARDWARE

| ORDER # | ITEM # | LIST |
|----------|-----------------------------------|---------|
| 735-4000 | SRG #4 Guard Key | \$21.88 |
| 735-2262 | SRG 4110-003 Safe Deposit Lock | \$44.68 |
| 735-2263 | SRG 4111-003 Safe Deposit Lock | \$44.69 |
| 735-2264 | SRG 4112-003 Safe Deposit Lock | \$44.69 |
| 735-4113 | SRG 4113-003 Safe Deposit Lock | \$44.69 |
| 735-2266 | SRG 4231-002 LH Safe Deposit Lock | \$44.63 |
| 735-2337 | SRG 4231-002-001-OBR LH Lid | \$22.72 |
| 735-2279 | SRG 4231-002-001-ONI LH Lid | \$22.72 |
| 735-2278 | SRG 4231-002-002-OBR RH Lid | \$22.71 |
| 735-2280 | SRG 4231-004-001-OBR Back Plug | \$11.74 |
| 735-2267 | SRG 4231-008 RH Safe Deposit Lock | \$44.63 |
| 735-2282 | SRG 4400-005-040 #0 Lever | CALL |
| 735-2283 | SRG 4400-005-041 #1 Lever | CALL |
| 735-2284 | SRG 4400-005-042 #2 Lever | CALL |
| 735-2285 | SRG 4400-005-043 #3 Lever | CALL |

| ORDER # | ITEM # | LIST |
|----------|-------------------------------------|---------|
| 735-2286 | SRG 4400-005-044 #4 Lever | CALL |
| 735-2287 | SRG 4400-005-045 #5 Lever | CALL |
| 735-2288 | SRG 4400-005-046 #6 Lever | CALL |
| 735-2289 | SRG 4400-005-047 #7 Lever | CALL |
| 735-2290 | SRG 4400-005-048 #8 Lever | CALL |
| 735-2268 | SRG 4420-010 LH Safe Deposit Lock | \$44.63 |
| 735-2291 | SRG 4440-001-002 RH Case | \$23.62 |
| 735-2292 | SRG 4440-001-003 LH Case | \$23.62 |
| 735-2294 | SRG 4440-002-006-ONI RH Lid | \$14.84 |
| 735-2039 | SRG 4440-002-006BR Cover, RH, Brass | \$14.84 |
| 735-2295 | SRG 4440-002-007-OBR LH Lid | \$14.84 |
| 735-2296 | SRG 4440-002-007ONI LH LID | \$14.84 |
| 735-2297 | SRG 4440-004-077-OBR Back Plug | \$7.81 |
| 735-2299 | SRG 4440-004-077-ONI Back Plug | \$7.81 |
| 735-2300 | SRG 4440-004-080-ONI Renter Plug | \$7.81 |

SAFE DEPOSIT HARDWARE

SARGENT AND GREENLEAF®

| ORDER # | ITEM # | LIST |
|----------|---|---------|
| 735-2042 | SRG 4440-004-0800BR 1/2" Front Plug Flat, Brass | \$7.81 |
| 735-2044 | SRG 4440-016-002 Front Cam | \$4.62 |
| 735-2301 | SRG 4440-016-002-000 Cam | \$4.62 |
| 735-5440 | SRG 4440-018 LH Safe Deposit Lock | \$44.63 |
| 735-4440 | SRG 4440-070 RH Safe Deposit Lock | \$44.63 |
| 735-2302 | SRG 4440-138-000 .048 Regular Spacer | \$5.22 |
| 735-2303 | SRG 4440-138-002 .073THK Spacer | \$5.22 |
| 735-2304 | SRG 4440-138-003 .025 THIN Spacer | \$3.27 |
| 735-2045 | SRG 4442-002-0030BR Cover, RH Brass | \$18.73 |
| 735-2046 | SRG 4442-002-004 LH Cover | \$13.50 |
| 735-2306 | SRG 4442-002-004-OBR LH Lid | \$19.10 |
| 735-5442 | SRG 4442-004 LH Safe Deposit Lock | \$44.63 |
| 735-4442 | SRG 4442-014 RH Safe Deposit Lock | \$44.63 |
| 735-2047 | SRG 4443-002-0030BR Cover, RH Brass | \$19.96 |
| 735-2308 | SRG 4443-002-004-OBR LH Lid | \$19.96 |
| 735-2309 | SRG 4443-002-040 LH ONI Lid | CALL |
| 735-2310 | SRG 4443-003-002 RH Bolt | \$15.97 |
| 735-2311 | SRG 4443-003-003 LH Bolt | \$15.97 |
| 735-2312 | SRG 4443-004-079-OBR Back Plug | \$10.43 |
| 735-2052 | SRG 4443-004-0820BR Front Plug, Brass | \$7.97 |
| 735-2314 | SRG 4443-004-087-OBR GRV Renter Plug | CALL |
| 735-2315 | SRG 4443-004-087ONI GRV Front Plug | CALL |
| 735-2316 | SRG 4443-004-089 Back Plug Grooved ONI | CALL |
| 735-2272 | SRG 4443-008 LH Safe Deposit Lock | \$44.63 |
| 735-4443 | SRG 4443-028 RH Large Double Nose Safe Deposit Lock, 1/2" Nose, Brass | \$44.63 |
| 735-4444 | SRG 4444-002 RH Safe Deposit Lock | \$87.93 |
| 735-2317 | SRG 4444-003-001 Bolt for 4444 | \$22.98 |
| 735-2274 | SRG 4544-020 DBL.CHG.3/8' Lefebure | \$47.11 |
| 735-2275 | SRG 4544-501 ONI | \$51.51 |
| 735-2276 | SRG 4545-004 Double Changeable Safe | \$48.91 |
| 735-2277 | SRG 4565-004 Fixed Lever Lock | \$44.63 |
| 735-4003 | SRG ST4 Cut Guard Key for 4443 Lock | CALL |

SAFETY DEPOSIT KEYBLANKS

| ORDER # | ITEM # | LIST |
|----------|--|---------|
| 735-0065 | SRG 1387 Ilco | CALL |
| 735-0067 | SRG 9500-002 - SY3B Guard Key for 4321 | \$14.26 |
| 735-0068 | SRG 9500-009 - 87G Grooved | CALL |
| 735-0069 | SRG 9500-010 - 89 | \$4.59 |
| 735-0070 | SRG 9500-011 - 89G | \$8.38 |
| 735-0071 | SRG 9500-012 - 89A | CALL |
| 735-0072 | SRG 9500-013 - 89AG | CALL |
| 735-0073 | SRG 9500-015 - 92 | CALL |
| 735-0074 | SRG 9500-016 - 92H for R132 | \$3.59 |
| 735-0075 | SRG 9500-018 - 91 Guard Blank | CALL |
| 735-0076 | SRG 9500-022 - 60G | CALL |
| 735-0077 | SRG 9500-026 - 87H Cut Guard Key (ea.) | \$23.88 |
| 735-0078 | SRG 9500-027 - 60 Cut Guard Key (ea.) | \$23.88 |
| 735-0079 | SRG 9500-029 BA4 Guard Key for 4500 | \$22.09 |
| 735-0096 | SRG 9500-003 96 Renters Key | \$3.01 |
| 735-0187 | SRG 9500-001 87H Guard Key | \$4.62 |
| 735-2339 | SRG 9500-002 Cut Key | \$14.26 |
| 735-4000 | SRG #4 Guard Key | \$21.88 |

951C High Security Padlock

Commercial keyway (S1) version of the Model 951 padlock

951 NSN: 5340-01-217-5068

951 Federal Specification: MIL-DTL-43607J

The Model 951 represents the most advanced security features found in any padlock. Constructed with special barrier materials inside the body and shackle to resist cutting and sawing, it is ideal for perimeter security and any location where the highest level of resistance to forced entry is required—making it the ultimate padlock.



We can also repair and service this product!

Features

- This rugged, key retaining padlock is built to conform to rigid specifications for indoor and outdoor high security applications—Ideal for perimeter security and any location requiring a high degree of resistance to forced entry.
- Easily field disassembled by use of a control key for service or rekeying.
- Equipped with a commercially available, high security Medeco Biaxial key cylinder.
- Cast stainless steel body.
- Body and shackle incorporate exotic barrier materials for maximum resistance against cutting, drilling, and sawing.
- Shrouded shackle offers 5/8" clear opening and provides a high degree of resistance against common wedging attacks.

Dimensions

Shackle Material: Hardened Steel

Shackle Diameter: 1/2"

Throat Opening in Shackle Shroud: 3/4" W x 7/16" H

Clear Shackle Opening When Locked: 5/8"

Overall Dimensions: 4-11/16" H x 2-3/4" W x 1-13/16" D

Weight: 4 lbs.

| ORDER # | ITEM # | LIST |
|----------|---|------------|
| 735-2333 | SRG 951-009 KD 1 Control Key, 2 Operator Keys, Includes attached chain and clevis | \$3,141.51 |

Special keying options available!

Southern Lock's experts can rekey or build your padlock to order quickly with our extensive inventory.

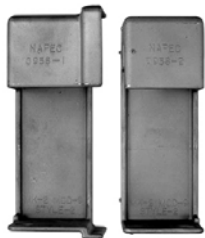

0958 Napec Shrouded Left Hasp

NSN: 5340-01-235-6907

Left hand style for use on sliding and hinged doors.

| ORDER # | ITEM # | LIST |
|----------|--------------------|----------|
| 845-2417 | 0958 Napec LH Hasp | \$650.00 |

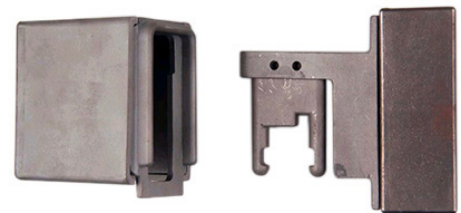

1300 Napec Shipboard Hasp

NSN: 5340-01-281-7938

Left hand or right hand doors swinging out to open.

| ORDER # | ITEM # | LIST |
|----------|----------------------------|----------|
| 845-2418 | 1300 Napec Style 1 Hasp | \$995.00 |



0957 Napec Shrouded Right Hasp

NSN: 5340-01-196-2547

Right hand style for use on sliding and hinged doors.

| ORDER # | ITEM # | LIST |
|----------|--------------------|----------|
| 845-2419 | 0957 Napec RH Hasp | \$650.00 |



0881/0883 Environmental Padlocks

The Model 0881/0883 environmental padlock is designed to protect against both physical attacks and harsh weather. It was made to withstand **extreme weather** for extended periods of time, and still open with the correct key when needed. With **self-cleaning locking cylinders**, the Model 0881/0883 opens quickly and easily even under the toughest conditions. Ideal for outdoor use in any climate, S&G environmental padlocks have become the standard of security in the railroad, utility, construction and refinery industries.



Features

- **BUILT-IN SECURITY.** The highly durable shackles in the Environmental Padlock are double ball locked to resist shimming, pulling, cutting, and sawing attacks. We added a powdered metal steel body around the locking cylinder for even greater security.
- **ALL-WEATHER PERFORMANCE.** With electroless plating inside and out and unique flow-through drain holes to keep water out of the lock, the Environmental Padlock delivers exceptional corrosion resistance. Self-cleaning lock cylinders sweep dirt and grit out with every operation.
- **FLEXIBLE SIZING.** Environmental Padlocks are available in two shackle sizes to fit most outdoor applications.

Case hardened (9/16") or stainless steel (3/8") shackle for maximum pull resistance

Unique top-loaded cylinder can only be accessed when shackle is in unlocked and open position

Electroless nickel plating inside and out to resist corrosion

Dual deadlocking shackle to prevent shimming and shackle pulling

Fluorocarbon o-ring diverts water from cylinder

Powdered metal steel body built up around cylinder, with narrow shoulder to reduce leverage points

Unique flow-through drain holes

Key retained when unlocked for higher security

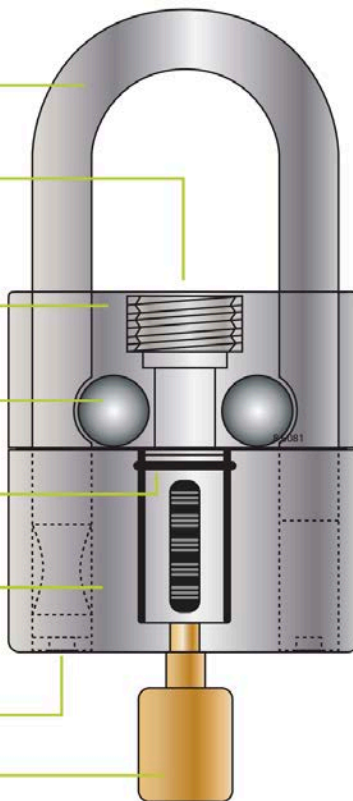

Southern Lock's experts will build your padlock to order!

Whether you need keys cut to code or want to add padlocks to existing key codes, we can service all your EP padlock needs quickly with our extensive inventory.

MODEL 0881 9/16" Shackle Diameter

Body Width: 2.75" • Body Height: 1.996"
Shackle Clearance: 1.875" • 5-pin disc tumbler

| ORDER # | ITEM # | LIST |
|----------|--|-----------------|
| 735-2102 | SRG 81-011 9/16" Padlock KA or KD (Keys sold separately, see below) | \$223.82 |
| 735-2100 | SRG 0881 Standard Strength Cut Key* | \$24.55 |

* Key blanks are not available for purchase, cut keys only

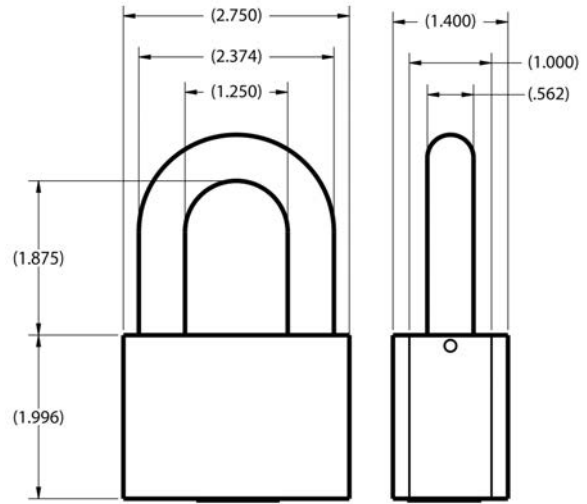

MODEL 0883 3/8" Shackle Diameter

Body Width: 1.88" • Body Height: 1.916"
Shackle Clearance: 1.125" • 6-pin disc tumbler

| ORDER # | ITEM # | LIST |
|----------|---|-----------------|
| 735-2111 | SRG 83-004 / 883 KD (Factory keyed, 2 keys per lock) | \$166.73 |
| 735-2112 | SRG 0883-003 3/8" Padlock KA (Keys sold separately, see below) | \$150.21 |
| 735-2109 | SRG 0883-047-001 Std. Strength Cut Key* | \$23.26 |

* Key blanks are not available for purchase, cut keys only

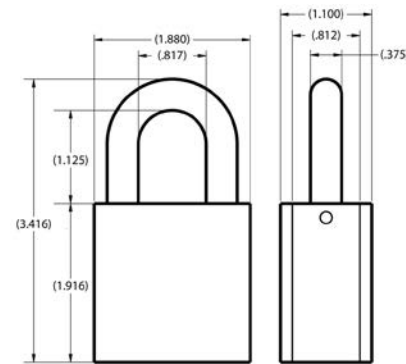

8077AD Combination Padlocks

NSN: 5340-00-285-6523 (GSA), 5340-01-196-2568 (DLA), 5340-01-217-2009

Meets **Federal Specification FF-P-110J**, used in large quantities by government agencies to secure file cabinet locking bars. It can be set to new combinations using the included change key.

Features

- Conforms to stringent government specifications, including 30 minute protection against expert manipulation and 10 minute protection against surreptitious entry attack.
- Field changeable combination with the use of a change key.
- 125,000 possible combinations.
- Packaged with change key and complete operating/changing instructions.



| ORDER # | ITEM # | LIST |
|----------|----------------------------------|-----------------|
| 735-8077 | SRG 8077-108 Combination Padlock | \$468.58 |
| 735-2227 | SRG 8077-043 Change Key Only | \$14.59 |

Dimensions

Shackle Material: Case Hardened Steel
Shackle Diameter: 5/16"
Clear Shackle Opening When Locked: 7/8"
Overall Dimensions: 4-5/32" H x 2-3/8" W x 1-31/32" D
Weight: 1.75 lbs.

Southern Lock & Supply Co.
727-541-5536 | www.southernlock.com

Main Florida Warehouse

Toll-Free: 800-282-2837
Fax: 800-447-2299
PO Box 1980,
Pinellas Park, FL 33780

South Florida

Toll Free: 888-780-6071
Fax: 954-943-4211
1445 SW 6th Ct.,
Pompano Beach, FL 33069

Charlotte

Toll-Free: 888-571-9145,
Fax: 704-527-0058
8200-C Arrowridge Blvd,
Charlotte, NC 28273